



DRESSAGE RULES

25th edition, effective 1st January 2014

Including updates effective 1st January ~~2022~~2021

Printed in Switzerland
Copyright © ~~2020-2022~~ Fédération Equestre Internationale
Reproduction strictly reserved

Fédération Equestre Internationale
HM King Hussein I Building
Chemin de la Joliette 8
1006 Lausanne
Switzerland

t +41 21 310 47 47

f +41 21 310 47 60
e info@fei.org
www.fei.org

TABLE OF CONTENTS

PREAMBLE	5
FEI CODE OF CONDUCT FOR THE WELFARE OF THE HORSE	6
ARTICLE 401 OBJECT AND GENERAL PRINCIPLES OF DRESSAGE	9
ARTICLE 402 THE HALT	9
ARTICLE 403 THE WALK	10
ARTICLE 404 THE TROT	11
ARTICLE 405 THE CANTER	13
ARTICLE 406 REINBACK	14
ARTICLE 407 THE TRANSITIONS	15
ARTICLE 408 THE HALF HALTS	15
ARTICLE 409 THE CHANGES OF DIRECTIONS	15
ARTICLE 410 THE FIGURES	16
ARTICLE 411 LEG-YIELDING	17
ARTICLE 412 LATERAL MOVEMENTS	17
ARTICLE 413 THE PIROUETTE, THE HALF-PIROUETTE AND TURN ON THE HAUNCHES	20
ARTICLE 414 THE PASSAGE	21
ARTICLE 415 THE PIAFFE	21
ARTICLE 416 THE IMPULSION / THE SUBMISSION	22
ARTICLE 417 THE COLLECTION	23
ARTICLE 418 THE POSITION AND AIDS OF THE ATHLETE	24
ARTICLE 419 OBJECT OF INTERNATIONAL DRESSAGE EVENTS	25
ARTICLE 420 CATEGORIES OF INTERNATIONAL DRESSAGE EVENTS	25
ARTICLE 421 TESTS	26
ARTICLE 422 CONDITIONS OF PARTICIPATION	27
ARTICLE 423 INVITATIONS, ENTRIES AND SUBSTITUTIONS	35
ARTICLE 424 DECLARATION OF STARTERS	36
ARTICLE 425 DRAW FOR THE STARTING ORDER	37
ARTICLE 426 ATHLETE WEIGHT	39
ARTICLE 427 DRESS	39
ARTICLE 428 SADDLERY	40
ARTICLE 429 ARENA AND EXERCISE AREAS (FOR DIAGRAM SEE ANNEX ARENA)	43
ARTICLE 430 EXECUTION OF THE TESTS	46
ARTICLE 431 TIME	49

ARTICLE 432	MARKING	49
ARTICLE 433	JUDGES' SHEETS	50
ARTICLE 434	CLASSIFICATION	50
ARTICLE 435	CALCULATION AND PUBLISHING OF RESULTS	51
ARTICLE 436	PRIZE-GIVING	52
CHAPTER III	GROUND JURY, JUDGES' SUPERVISORY PANEL, VETERINARY COMMISSION AND VETERINARY DELEGATE, STEWARDS AND ABUSE OF HORSES	54
ARTICLE 437	GROUND JURY	54
ARTICLE 438	JUDGES SUPERVISORY PANEL (JSP)	57
ARTICLE 439	APPEAL COMMITTEE	58
ARTICLE 440	ABUSE OF HORSES	58
ARTICLE 441	VETERINARY COMMISSION AND FEI VETERINARY DELEGATE ...	58
ARTICLE 442	STEWARDS	58
CHAPTER IV	HORSE INSPECTIONS AND EXAMINATIONS, MEDICATION CONTROL AND PASSPORTS OF HORSES	59
ARTICLE 443	HORSE INSPECTIONS, EXAMINATIONS AND PASSPORTS OF HORSES	59
ARTICLE 444	MEDICATION CONTROL OF HORSES	59
CHAPTER V	CDIOS, SENIOR WORLD, CONTINENTAL, REGIONAL, INDIVIDUAL AND TEAM FEI DRESSAGE CHAMPIONSHIPS AND GAMES	60
ARTICLE 445	CDIOS	60
ARTICLE 446	FEI CHAMPIONSHIPS- ORGANISATION	61
ARTICLE 447	GROUND JURY AND TECHNICAL DELEGATE	62
ARTICLE 449	PARTICIPATION	63
ARTICLE 450	QUALIFICATION CRITERIA	64
ARTICLE 451	EXPENSES AND PRIVILEGES – ATHLETES, GROOMS, CHEF D'EQUIPE AND TEAM VETERINARIAN	64
ARTICLE 452	CLASSIFICATION	64
ANNEX 1 – YOUTH ATHLETES CATEGORIES	66
CHAPTER I	INTRODUCTION	66
ARTICLE 1	GENERAL	66
ARTICLE 2	PRIORITY OF RULES AND REGULATIONS	66
CHAPTER II	ELIGIBILITY AT INTERNATIONAL EVENTS	66
ARTICLE 3	GENERAL	66
ARTICLE 4	PARTICIPATION	66
CHAPTER III	INTERNATIONAL EVENTS	67
ARTICLE 5	INTERNATIONAL EVENTS	67

ARTICLE 6 CHAMPIONSHIPS	69
CHAPTER IV OTHER SPECIFICATIONS	69
ARTICLE 7 EXPENSES AND PRIVILEGES	69
ARTICLE 8 PRIZES	70
ARTICLE 9 SCHOOLING OF HORSES	70
CHAPTER V CONTINENTAL AND REGIONAL CHAMPIONSHIPS	71
ARTICLE 10 ENTRIES	71
ARTICLE 11 QUALIFICATIONS	71
ARTICLE 12 COMPETITIONS AND TESTS	71
ARTICLE 13 TEAM AND INDIVIDUAL CLASSIFICATION	73
ARTICLE 14 PRIZES AND PRIZE MONEY	73
ANNEX 2 – INTERNATIONAL DRESSAGE JUDGES	74
ANNEX 3 - DIRECTIVES FOR CDI/CDIO WITH BORROWED HORSES	76
ANNEX 4 - PAS DE DEUX	78
ANNEX 5 - STABLE SECURITY	79
ANNEX 6 – DRESSAGE ARENA	80
ANNEX 7 – CATEGORIES OF INTERNATIONAL DRESSAGE EVENTS	81
ANNEX 8 - BADGES OF HONOUR	91
ANNEX 9 – CODEX FOR FEI DRESSAGE JUDGES	92
ANNEX 10 - PER DIEM	94
ANNEX 11 – EQUIPMENT/SADDLERY REFERENCE	95

PREAMBLE

The present Rules for Dressage Events are the 25th edition, effective 1st January 2014. The Rules include Dressage Rules for U25, Young Riders, Juniors, Pony Riders and Children (the "Dressage Rules").

All other rules covering the same subject matter (other editions and all other official documents) issued previously are superseded.

Although these Rules set out the detailed rules of the Fédération Equestre Internationale ("FEI") governing International Dressage Events, they must be read in conjunction with the Statutes, the General Regulations (hereinafter GRs), the Veterinary Regulations (hereinafter VRs), and all other FEI Rules and Regulations.

Every eventuality cannot be provided for in these Dressage Rules. In any unforeseen or exceptional circumstances, it is the duty of the Ground Jury or the relevant person or body to make a decision in a sporting spirit, by approaching as near as possible the intention of the Dressage Rules and of the FEI GRs. Should there remain any omissions in the Dressage Rules, such omission shall be interpreted in a manner compatible to the fullest extent with the other provisions of these Dressage Rules, other Rules and Regulations of the FEI, and sporting spirit.

~~In the Dressage Rules, the use of the masculine shall be interpreted to also include the feminine form.~~

Any terms with the capitalised letter are defined in the Dressage Rules, in the FEI GRs or in the Statutes.

FEI CODE OF CONDUCT FOR THE WELFARE OF THE HORSE

The FEI requires all those involved in international equestrian sport to adhere to the FEI Code of Conduct and to acknowledge and accept that at all times the welfare of the Horse must be paramount. Welfare of the Horse must never be subordinated to competitive or commercial influences. The following points must be particularly adhered to:

1. General Welfare:

a) Good Horse management

Stabling and feeding must be compatible with the best Horse management practices. Clean and good quality forage, feed and water must always be available.

b) Training methods

Horses must only undergo training that matches their physical capabilities and level of maturity for their respective disciplines. They must not be subjected to methods which are abusive or cause fear.

c) Farriery and tack

Foot care and shoeing must be of a high standard. Tack must be designed and fitted to avoid the risk of pain or injury.

d) Transport

During transportation, Horses must be fully protected against injuries and other health risks. Vehicles must be safe, well ventilated, maintained to a high standard, disinfected regularly and are driven by competent personnel. Competent handlers must always be available to manage the Horses.

e) Transit

All journeys must be planned carefully, and Horses allowed regular rest periods with access to food and water in line with current FEI guidelines.

2. Fitness to compete:

a) Fitness and competence

Participation in Competition must be restricted to fit Horses and Athletes of proven competence. Horses must be allowed suitable rest period between training and competitions; additional rest periods should be allowed following travelling.

b) Health status

No Horse deemed unfit to compete may compete or continue to compete, veterinary advice must be sought whenever there is any doubt.

c) Doping and Medication

Any action or intent of doping and illicit use of medication constitute a serious welfare issue and will not be tolerated. After any veterinary treatment, sufficient time must be allowed for full recovery before Competition.

d) Surgical procedures

Any surgical procedures that threaten a competing Horse's welfare or the safety of other Horses and/or Athletes must not be allowed.

e) Pregnant/recently foaled mares

Mares must not compete after their fourth month of pregnancy or with foal at foot.

f) Misuse of aids

Abuse of a Horse using natural riding aids or artificial aids (e.g. whips, spurs, etc.) will not be tolerated.

3. Events must not prejudice Horse welfare:

a) Competition areas

Horses must be trained and compete on suitable and safe surfaces. All obstacles and competition conditions must be designed with the safety of the Horse in mind.

b) Ground surfaces

All ground surfaces on which Horses walk, train or compete must be designed and maintained to reduce factors that could lead to injury.

c) Extreme weather

Competitions must not take place in extreme weather conditions that may compromise welfare or safety of the Horse. Provision must be made for cooling conditions and equipment for Horses after competing.

d) Stabling at Events

Stables must be safe, hygienic, comfortable, well ventilated and of sufficient size for the type and disposition of the Horse. Washing-down areas and water must always be available.

4. Humane treatment of Horses:

a) Veterinary treatment

Veterinary expertise must always be available at an Event. If a Horse is injured or exhausted during a Competition, the Athlete must stop competing and a veterinary evaluation must be performed.

b) Referral centres

Wherever necessary, Horses should be collected by ambulance and transported to the nearest relevant treatment centre for further assessment and therapy. Injured Horses must be given full supportive treatment before being transported.

c) Competition injuries

The incidence of injuries sustained in Competition should be monitored. Ground surface conditions, frequency of Competitions and any other risk factors should be examined carefully to indicate ways to minimise injuries.

d) Euthanasia

If injuries are sufficiently severe a Horse may need to be euthanized on humane grounds by a veterinarian as soon as possible, with the sole aim of minimising suffering.

e) Retirement

Horses must be treated sympathetically and humanely when they retire from Competition.

5. **Education:**

The FEI urges all those involved in equestrian sport to attain the highest possible levels of education in areas of expertise relevant to the care and management of the Competition Horse.

This Code of Conduct for the Welfare of the Horse may be modified from time to time and the views of all are welcomed. Particular attention will be paid to new research findings and the FEI encourages further funding and support for welfare studies.

CHAPTER I DRESSAGE

ARTICLE 401 OBJECT AND GENERAL PRINCIPLES OF DRESSAGE

1. The object of Dressage is the development of the Horse into a happy Athlete through harmonious education. As a result, it makes the Horse calm, supple, loose and flexible, but also confident, attentive and keen, thus achieving perfect understanding with the Athlete.

These qualities are demonstrated by:

- The freedom and regularity of the paces.
 - The harmony, lightness and ease of the movements.
 - The lightness of the forehand and the engagement of the hindquarters, originating from a lively impulsion.
 - The acceptance of the bit, with submissiveness/throughness (Durchlässigkeit) without any tension or resistance.
2. The Horse thus gives the impression of doing, of its own accord, what is required. Confident and attentive, submitting generously to the control of the Athlete, remaining absolutely straight in any movement on a straight line and bending accordingly when moving on curved lines.
 3. The walk is regular, free and unconstrained. The trot is free, supple, regular and active. The canter is united, light and balanced. The hindquarters are never inactive or sluggish. The Horse responds to the slightest indication of the Athlete and thereby gives life and spirit to all the rest of its body.
 4. By virtue of a lively impulsion and the suppleness of the joints, free from the paralysing effects of resistance, the Horse obeys willingly and without hesitation and responds to the various aids calmly and with precision, displaying a natural and harmonious balance both physically and mentally.
 5. In all the work, even at the halt, the Horse must be "on the bit". A Horse is said to be "on the bit" when the neck is more or less raised and arched according to the stage of training and the extension or collection of the pace, accepting the bridle with a light and consistent soft submissive contact. The head should remain in a steady position, as a rule slightly in front of the vertical, with a supple poll as the highest point of the neck, and no resistance should be offered to the Athlete.
 6. Cadence is shown in trot and canter and is the result of the proper harmony that a Horse shows when it moves with well-marked regularity, impulsion and balance. Cadence must be maintained in all the different trot or canter exercises and in all the variations of these paces.
 7. The regularity of the paces is fundamental to Dressage.

ARTICLE 402 THE HALT

1. At the halt the Horse should stand attentive, engaged, motionless, straight and square with the weight evenly distributed over all four (4) legs. The neck should be raised with the poll as the highest point and the nose line slightly in front of the vertical. While remaining "on the bit" and maintaining a light and soft contact with the Athlete's hand, the Horse may quietly chew the bit and should be ready to move off at the slightest indication of the Athlete. The halt must be shown for at least 3 seconds. The halt should be shown throughout the salute.

2. The halt is obtained by the displacement of the Horse's weight to the hindquarters by a properly increased action of the seat and legs of the Athlete, driving the Horse towards a softly closed hand, causing an almost instantaneous but not abrupt halt at a previously fixed place. The halt is prepared by a series of half-halts (see transitions).
3. The quality of the paces before and after the halt is an integral part of the assessment.

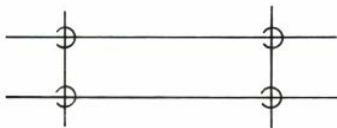
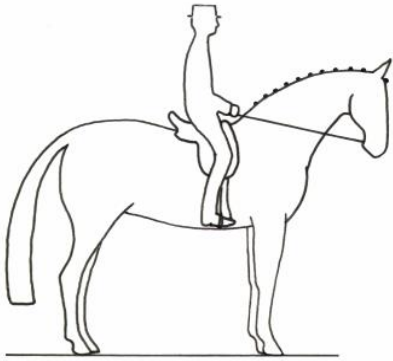

ARTICLE 403 THE WALK

1. The walk is a marching pace in a regular and well-marked four (4) times beat with equal intervals between each beat. This regularity combined with full relaxation must be maintained throughout all walk movements.
2. When the foreleg and the hind leg on the same side move almost on the same beat, the walk tends to become an almost lateral movement. This irregularity, which might become an ambling movement, is a serious deterioration of the pace.
3. The following walks are recognised: Medium walk, Collected walk, Extended walk and Free walk. There should always be a clear difference in the attitude and overtracking in these variations.
 - 3.1. **Medium walk.** A clear, regular and unconstrained walk of moderate lengthening. The Horse, remaining "on the bit", walks energetically but relaxed with even and determined steps, the hind feet touching the ground in front of the hoof prints of the fore feet. The Athlete maintains a light, soft and steady contact with the mouth, allowing the natural movement of the Horse's head and neck.
 - 3.2. **Collected walk.** The Horse, remains "on the bit", moves resolutely forward, with its neck raised and arched and showing a clear self-carriage. The head approaches the vertical position and a light contact is maintained with the mouth. The hind legs are engaged with good hock action. The pace should remain marching and vigorous, the feet being placed in regular sequence. The steps cover less ground and are higher than at the medium walk, because all the joints bend more markedly. The Collected walk is shorter than the Medium walk, although showing greater activity.
 - 3.3. **Extended walk.** The Horse covers as much ground as possible, without haste and without losing the regularity of the steps. The hind feet touch the ground clearly in front of the hoof prints of the fore feet. The Athlete allows the Horse to stretch out the head and neck (forward

and downwards) without losing contact with the mouth and control of the poll. The nose must be clearly in front of the vertical.

- 3.4. **Free Walk.** The free walk is a pace of relaxation in which the Horse is allowed complete freedom to lower and stretch out the head and neck. The degree of ground cover and length of strides, with hind feet stepping clearly in front of the footprints of the front feet, are essential to the quality of the free walk.

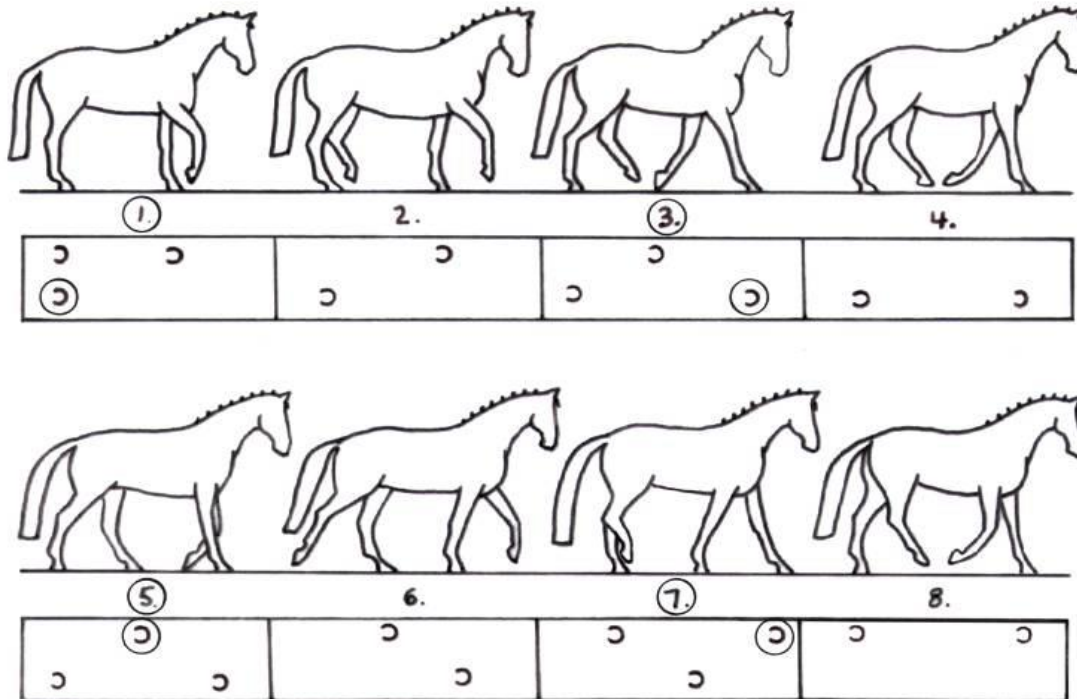

The walk is a pace in four (4)-beat rhythm with eight (8) phases (numbers in circles indicate the beat).

- 3.5. **Stretching on a long rein.** This exercise gives a clear impression of the "throughness" of the Horse and proves its balance, suppleness, obedience and relaxation. In order to execute the exercise "stretching on a long rein" correctly, the Athlete must lengthen the reins as the Horse stretches gradually forward and downward. As the neck stretches forwards and downwards, the mouth should reach more or less to the horizontal line corresponding with the point of the shoulder. An elastic and consistent contact with the Athlete's hands must be maintained. The pace must maintain its rhythm, and the Horse should remain light in the shoulders with the hindlegs well engaged. During the retake of the reins the Horse must accept the contact without resistance in the mouth or poll.

ARTICLE 404 THE TROT

1. The trot is a two (2)-beat pace of alternate diagonal legs (left fore and right hind leg and vice versa) separated by a moment of suspension.
2. The trot should show free, active and regular steps.
3. The quality of the trot is judged by general impression, i.e. the regularity and elasticity of the steps, the cadence and impulsion in both collection and extension. This quality originates from a supple back and well-engaged hindquarters, and by the ability to maintain the same rhythm and natural balance with all variations of the trot.
4. The following trots are recognised: Working trot, Lengthening of steps, Collected trot, Medium trot and Extended trot.

- 4.1. **Working trot.** This is a pace between the Collected and the Medium trot, in which a Horse's training is not yet developed enough and ready for collected movements. The Horse shows proper balance and, remaining "on the bit", goes forward with even, elastic steps and good hock action. The expression "good hock action" underlines the importance of an impulsion originating from the activity of the hindquarters.
- 4.2. **Lengthening of steps.** In the test for four (4)-year-old Horses "lengthening of steps" is required. This is a variation between the Working and Medium trot in which a Horse's training is not developed enough for Medium trot.
- 4.3. **Collected trot.** The Horse, remaining "on the bit", moves forward with the neck raised and arched. The hocks, being well-engaged and flexed, must maintain an energetic impulsion, enabling the shoulders to move with greater mobility, thus demonstrating complete self-carriage. Although the Horse's steps are shorter than in the other trots, elasticity and cadence are not lessened.
- 4.4. **Medium trot.** This is a pace of moderate lengthening compared to the Extended trot, but "rounder" than the latter. Without hurrying, the Horse goes forward with clearly lengthened steps and with impulsion from the hindquarters. The Athlete allows the Horse to carry the head a little more in front of the vertical than at the Collected and the Working trot, and to lower the head and neck slightly. The steps should be even, and the whole movement balanced and unconstrained.
- 4.5. **Extended trot.** The Horse covers as much ground as possible. Without hurrying, the steps are lengthened to the utmost as a result of great impulsion from the hindquarters. The Athlete allows the Horse to lengthen the frame and to gain ground whilst controlling the poll. The fore feet should touch the ground on the spot towards which they are pointing. The movement of the fore and hind legs should reach equally forward in the moment of extension. The whole movement should be well-balanced and the transition to Collected trot should be smoothly executed by taking more weight on the hindquarters.
5. All trot work is executed "sitting", unless otherwise indicated in the test.
6. **Stretching on a long rein.** This exercise gives a clear impression of the "throughness" of the Horse and proves its balance, suppleness, obedience and relaxation. In order to execute the exercise "stretching on a long rein" correctly, the Athlete must lengthen the reins as the Horse stretches gradually forward and downward. As the neck stretches forwards and downwards, the mouth should reach more or less to the horizontal line corresponding with the point of the shoulder. An elastic and consistent contact with the Athlete's hands must be maintained. The pace must maintain its rhythm, and the Horse should remain light in the shoulders with the hindlegs well-engaged. During the retake of the reins the Horse must accept the contact without resistance in the mouth or poll.

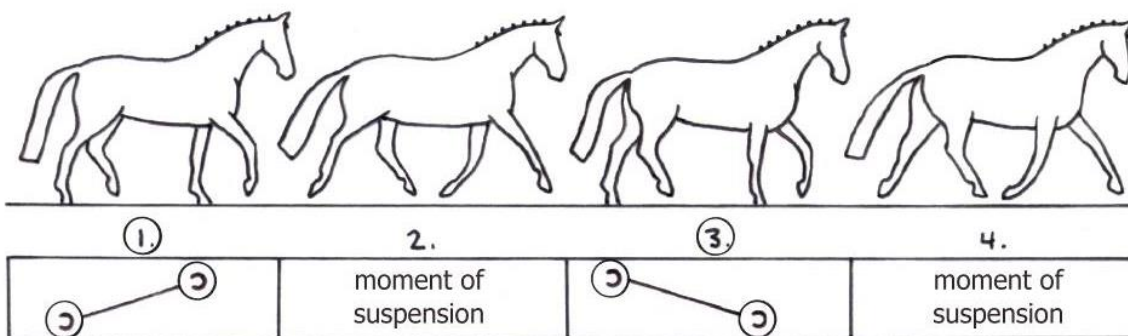

The trot is a pace in two (2)-beat rhythm with four (4) phases (Numbers in circles indicate the beat)

ARTICLE 405 THE CANTER

1. The canter is a three (3)-beat pace where, in canter to the right, for example, the footfall is as follows: left hind, left diagonal (simultaneously left fore and right hind), right fore, followed by a moment of suspension with all four (4) feet in the air before the next stride begins.
2. The canter, always with light, cadenced and regular strides, should be moved into without hesitation.
3. The quality of the canter is judged by the general impression, i.e. the regularity and lightness of the steps and the uphill tendency and cadence originating from the acceptance of the bridle with a supple poll and in the engagement of the hindquarters with an active hock action – and by the ability of maintaining the same rhythm and a natural balance, even after a transition from one (1) canter to another. The Horse should always remain straight on straight lines and correctly bent on curved lines.
4. The following canters are recognised: Working canter, Lengthening of strides, Collected canter, Medium canter and Extended canter.
 - 4.1. **Working canter.** This is a pace between the Collected and the Medium canter, in which a Horse's training is not yet developed enough and ready for collected movements. The Horse shows natural balance while remaining "on the bit", and goes forward with even, light and active strides and good hock action. The expression "good hock action" underlines the importance of an impulsion originating from the activity of the hindquarters.
 - 4.2. **Lengthening of strides.** In the test for four (4)-year-old Horses "lengthening of strides" is required. This is a variation between the Working and Medium canter in which a Horse's training is not developed enough for Medium canter.
 - 4.3. **Collected canter.** The Horse, remaining "on the bit", moves forward with the neck raised and arched. The hocks, being well-engaged, maintain an energetic impulsion, enabling the shoulders to move with greater mobility thus demonstrating self-carriage and an uphill tendency. The Horse's strides are shorter than in the other canters, without losing elasticity and cadence.
 - 4.4. **Medium canter.** This is a pace between the Working and the Extended canter. Without hurrying, the Horse goes forward with clearly lengthened strides and impulsion from the hindquarters. The Athlete allows the Horse to carry the head a little more in front of the vertical than in the Collected and Working canter, and at the same time allows the Horse, to lower the head and neck slightly. The strides should be balanced and unconstrained.
 - 4.5. **Extended canter.** The Horse covers as much ground as possible. Without hurrying, the strides are lengthened to the utmost. The Horse remains calm, light and straight as a result of great impulsion from the hindquarters. The Athlete allows the Horse to lengthen the frame with a controlled poll and to gain ground. The whole movement should be well-balanced and the transition to Collected canter should be smoothly executed by taking more weight on the hindquarters.
 - 4.6. **Counter-canter.** The Counter canter is a balancing and straightening movement that must be executed in collection. The Horse canters in correct sequence with the outside foreleg leading with positioning to the side of the leading leg. The foreleg should be aligned to the same track as the hind leg.
 - 4.7. **Simple change of leg at the canter.** This is a movement in which, after a direct transition out of the canter into a walk, with three (3) to five (5) clearly defined steps, an immediate transition is made into the other canter lead.
 - 4.8. **Flying change of leg.** The flying change is performed in one (1) stride with the front and hind legs changing at the same moment. The change of the leading front and hind leg takes place during the moment of suspension. The aids should be precise and unobtrusive.

Flying changes of leg can also be executed in series at every 4th, 3rd, 2nd or at every stride. The Horse, even in the series, remains light, calm and straight with lively impulsion, maintaining the same rhythm and balance throughout the series concerned. In order not to restrict or restrain the lightness, fluency and groundcover of the flying changes in series, enough impulsion must be maintained.

Aims of flying changes: To show the reaction, sensitivity and obedience of the Horse to the aids for the change of leg.

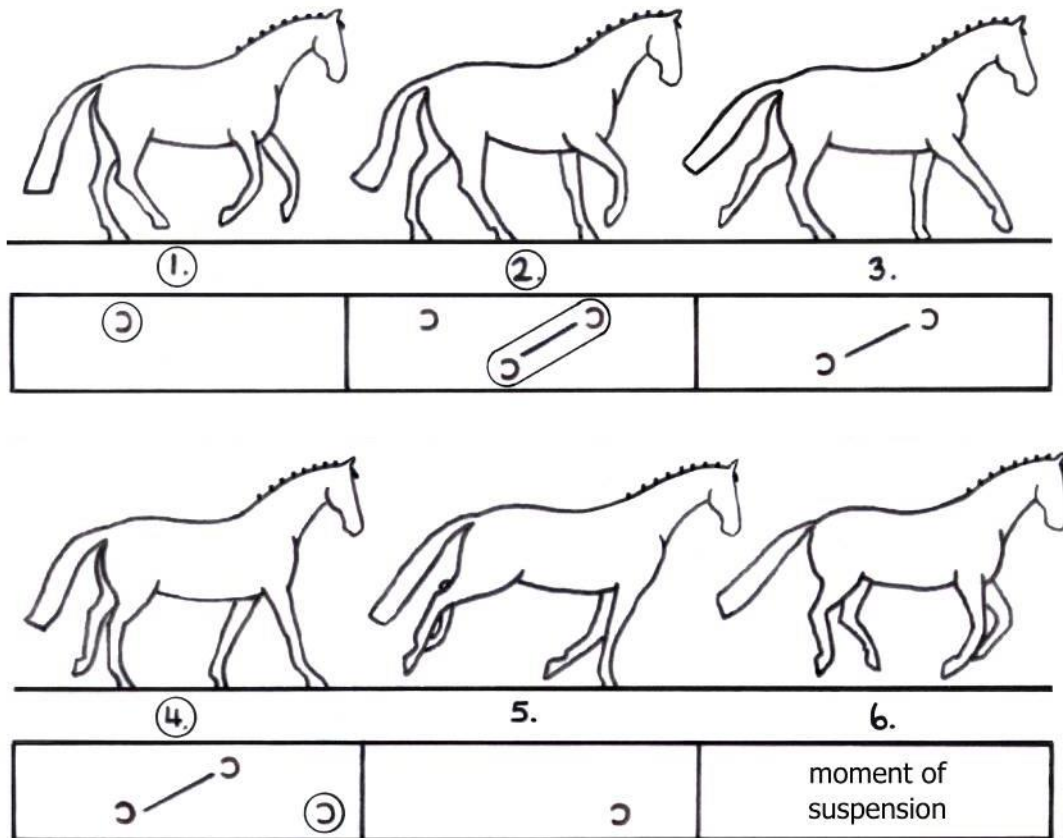

The canter is a pace in three-beat rhythm with six (6) phases

ARTICLE 406 REINBACK

1. Reinback is a rearward diagonal movement with a two (2)-beat rhythm but without a moment of suspension. Each diagonal pair of legs is raised and returned to the ground alternatively, with the forelegs aligned on the same track as the hindlegs.
2. During the entire exercise, the Horse should remain "on the bit", maintaining its desire to move forward.
3. Anticipation or precipitation of the movement, resistance to or evasion of the contact, deviation of the hindquarters from the straight line, spreading or inactive hind legs and dragging forefeet are serious faults.
4. The steps are counted as each foreleg moves back. After completing the required number of steps backward, the Horse should show a square halt or move forward in the required pace immediately. In tests where a Reinback of one (1) Horse's length is required, it should be executed with three (3) or four (4) steps.
5. Reinback series (Schaukel) is a combination of two (2) reinbacks with walk steps in between. It should be executed with fluent transitions and the required number of steps.

ARTICLE 407 THE TRANSITIONS

The changes of pace and variations within the paces should be exactly performed at the prescribed marker. The cadence (except in walk) should be maintained up to the moment when the pace or movement is changed or the Horse halts. The transitions within the paces must be clearly defined while maintaining the same rhythm and cadence throughout. The Horse should remain light in hand, calm, and maintain a correct position.

The same applies to transitions from one (1) movement to another, for instance from passage to piaffe or vice versa.

ARTICLE 408 THE HALF HALTS

Every movement or transition should be invisibly prepared by barely perceptible half halts. The half halt is an almost simultaneous, coordinated action of the seat, the legs and the hands of the Athlete, with the object of increasing the attention and balance of the Horse before the execution of the movements or transitions to lower and higher paces. By shifting slightly more weight onto the Horse's hindquarters, the engagement of the hind legs and the balance on the haunches are improved for the benefit of the lightness of the forehand and the Horse's balance as a whole.

ARTICLE 409 THE CHANGES OF DIRECTIONS

1. At changes of direction, the Horse should adjust the bend of the body to the curvature of the line it follows, remaining supple and following the indications of the Athlete, without any resistance or change of pace, rhythm or speed.
2. Changes of directions can be executed in the following ways:
 - a. Right-angled turn including riding through the corner (one -1- quarter of a volte of approx. six -6- metres).
 - b. Short and long diagonal.
 - c. Half voltes and half circles with change of rein.
 - d. Half pirouettes and turn on the haunches.
 - e. Serpentine loops.
 - f. Counter-changes of hand (in zig-zag)*. The Horse should be straight for a moment before changing direction.

*Zig-zag: A movement containing more than two (2) half-passes with changes of direction.

ARTICLE 410 THE FIGURES

The figures asked in Dressage tests are the voltes, the serpentines and the figures of eight.

1. **Volte**

The volte is a circle of six (6), eight (8) or ten (10) metres in diameter. If larger than ten (10) metres it is a circle.

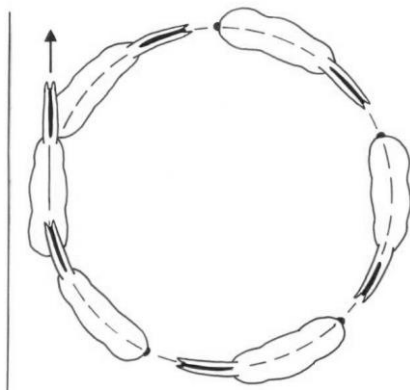

2. **Serpentine**

The serpentine with several loops touching the long side of the arena consists of half circles connected by a straight line. When crossing the centreline, the Horse should be parallel to the short side (a). Depending on the size of the half circles, the straight connection varies in length. Serpentines with one (1) loop on the long side of the arena are executed with five (5) metres or ten (10) metres distance from the track (b). Serpentines around the centre line are executed between the quarter lines (c).

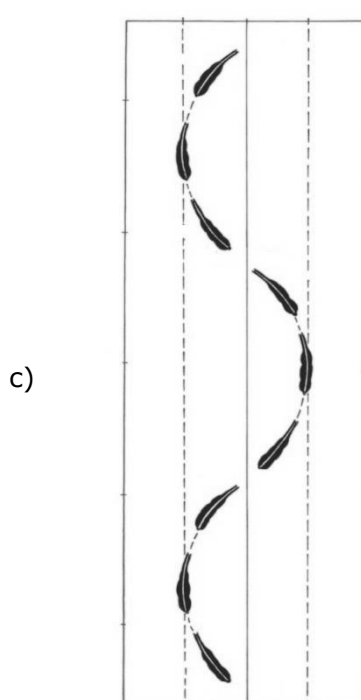
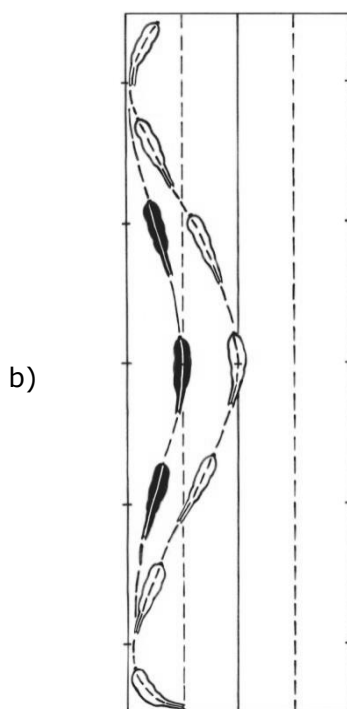
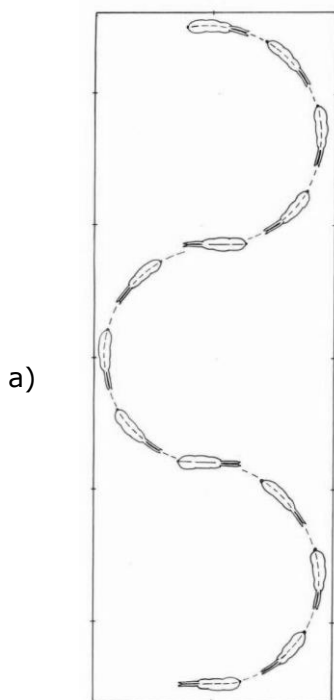

3. **Figure of eight**

This figure consists of two (2) voltes or circles of equal size as prescribed in the test, joined at the centre of the eight (8). The Athlete should make the Horse straight an instant before changing direction at the centre of the figure.

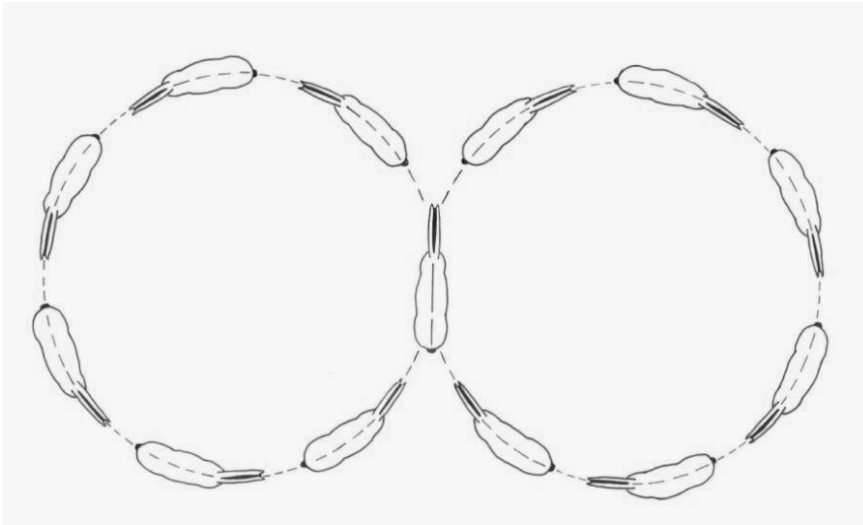

ARTICLE 411 LEG-YIELDING

1. The aim of leg yielding: To demonstrate the suppleness and lateral responsiveness of the Horse.
2. Leg-yielding is performed in Working trot in FEI Competitions. The Horse is almost straight, except for a slight flexion at the poll away from the direction in which it moves, so that the Athlete is just able to see the eyebrow and nostril on the inside. The inside legs pass and cross in front of the outside legs.

Leg-yielding should be included in the training of the Horse before it is ready for Collected work. Later on, together with the more advanced shoulder-in movement, it is the best means of making a Horse supple, loose and unconstrained for the benefit of the freedom, elasticity and regularity of its paces and the harmony, lightness and ease of its movements.

Leg yielding can be performed "on the diagonal" in which case the Horse should be as nearly as possible parallel to the long sides of the arena, although the forehand should be slightly in advance of the hindquarters. It can also be performed "along the wall" in which case the Horse should be at an angle of about thirty five (35) degrees to the direction in which it is moving.

ARTICLE 412 LATERAL MOVEMENTS

1. The main aim of lateral movements – except leg-yielding - is to develop and increase the engagement of the hindquarters and thereby also the collection.
2. In all lateral movements - shoulder-in, travers, renvers, and half-pass, the Horse is slightly bent and moves on different tracks.
3. The bend or flexion must never be exaggerated so that it does not impair the rhythm, the balance and fluency of the movement.
4. In the lateral movements, the pace should remain free and regular, maintaining a constant impulsion, yet it must be supple, cadenced and balanced. The impulsion is often lost because of the Athlete's preoccupation with bending the Horse and pushing it sideways.

5. **Shoulder-in.** The shoulder-in is performed in Collected trot. The Horse is ridden with a slight but uniform bend around the inside leg of the Athlete maintaining engagement and cadence and a constant angle of approx. thirty (30) degrees. The Horse's inside foreleg passes and crosses in front of the outside foreleg; the inside hind leg steps forward under the Horse's body weight following the same track of the outside foreleg, with the lowering of the inside hip. The Horse is bent away from the direction in which it is moving.
6. **Travers.** Travers can be performed in Collected trot or Collected canter. The Horse is slightly bent round the inside leg of the Athlete but with a greater degree of bend than in shoulder-in. A constant angle of approximately thirty five (35) degrees should be shown (from the front and from behind one -1- sees four -4- tracks). The forehand remains on the track and the quarters are moved inwards. The Horse's outside legs pass and cross in front of the inside legs. The Horse is bent in the direction in which it is moving.

To start the travers, the quarters must leave the track or, after a corner or circle, are not brought back onto the track. At the end of the travers, the quarters are brought back on the track (without any counter-flexion of the poll/neck) as one (1) would finish a circle.

Aims of travers: to show a fluent Collected trot movement on a straight line and a correct bend. Front and hind legs are crossing, balance and cadence are maintained.

7. **Renvers.** Renvers is the inverse movement in relation to travers. The hindquarters remain on the track while the forehand is moved inward. To finish the renvers the forehand is aligned with the quarters on the track. Otherwise, the same principles and conditions that apply to the travers are applicable to the renvers.

The Horse is slightly bent around the inside leg of the Athlete. The Horse's outside legs pass and cross in front of the inside legs. The Horse is bent in the direction in which it is moving.

Aims of renvers: to show a fluent Collected trot movement on a straight line with a greater degree of bend than in shoulder-in. Fore and hind legs cross, balance and cadence are maintained.

8. **Half pass.** Half-pass is a variation of travers, executed on a diagonal line instead of along the wall. It can be performed in Collected trot (and in passage in a freestyle) or Collected canter. The Horse should be slightly bent around the inside leg of the Athlete and in the direction in which it is moving. The Horse should maintain the same cadence and balance throughout the whole movement. In order to give more freedom and mobility to the shoulders, it is of great importance that the impulsion be maintained, especially the engagement of the inside hind leg. The Horse's body is nearly parallel to the long side of the arena with the forehand slightly in advance of the hindquarters.

In the trot, the outside legs pass and cross in front of the inside legs. In the canter, the movement is performed in a series of forward/sideways strides.

Aims of half-pass in trot: to show a fluent collected trot movement on a diagonal line with a greater degree of bend than in shoulder-in. Fore and hind legs cross, balance and cadence are maintained.

Aims of the half-pass in canter: to both demonstrate and develop the collection and suppleness of the canter by moving fluently forwards and sideways without any loss of rhythm, balance or softness and submission to the bend.

Leg yielding along the wall

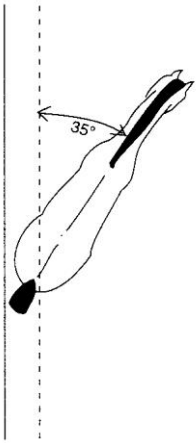

Leg yielding on the diagonal

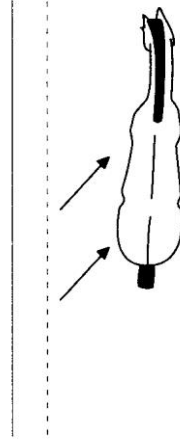

Shoulder in

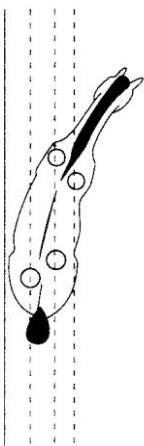

Travers

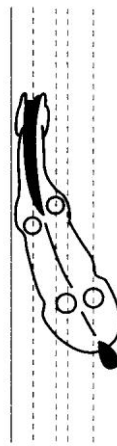

Renvers

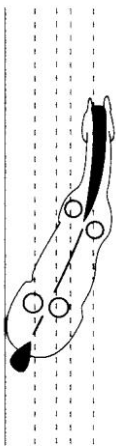

Half-Pass

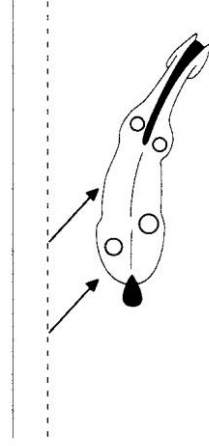

ARTICLE 413 THE PIROUETTE, THE HALF-PIROUETTE AND TURN ON THE HAUNCHES

1. The Pirouette (half-pirouette) is a turn of three hundred and sixty (360) degrees (hundred and eighty -180- degrees) executed on two (2) tracks, with a radius equal to the length of the Horse and the forehand moving around the haunches.
2. Pirouettes (half-pirouettes) are usually carried out at Collected walk or canter, but can also be executed at piaffe.
3. At the pirouette (half-pirouette) the forefeet and the outside hind foot move around the inside hind foot. The inside hind leg describes a circle as small as possible.
4. At whatever pace the pirouette (half-pirouette) is executed, the Horse, slightly bent in the direction in which it is turning, remains "on the bit" with light contact, turning smoothly around, and maintaining sequence and timing of footfalls of that pace. The poll remains the highest point during the entire movement.
5. During the pirouettes (half-pirouettes), the Horse should maintain its activity (walk also included) and never move backwards or sideways.
6. In executing the pirouette or the half-pirouette in canter, the Athlete should maintain lightness of the Horse while accentuating the collection. The Horse's hindquarters are well engaged and lowered and show a good flexion of the joints. An integral part of the movement is the quality of the canter strides before and after the pirouette. The strides should show an increased activity and collection before the pirouette and the balance should be maintained at the end of the pirouette.

Aims of the pirouette and half-pirouette in canter: to demonstrate the willingness of the Horse to turn around the inside hind leg on a small radius, slightly bent in the direction of the turn while maintaining the activity and the clarity of the canter, the straightness and the balance before and after the figure and clear canter strides during the turn. In the pirouette or half-pirouette in canter, the Judges should be able to recognize a real canter stride although the feet of the diagonal – inside hind leg, outside front leg – are not touching the ground simultaneously.

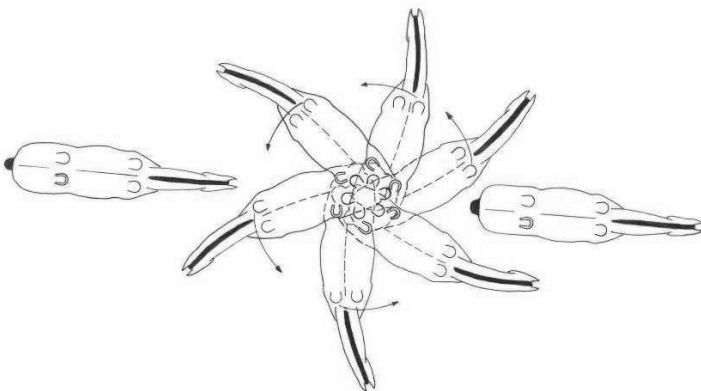

Pirouette and half-pirouette in canter

7. The quality of the pirouettes (half-pirouettes) is judged according to the suppleness, lightness and regularity, and the precision and smoothness of the entrance and exit. Pirouettes (half-pirouettes) in canter should be executed in six (6) to eight (8) strides – full pirouettes – and three to four (4) strides – half-pirouette.
8. Half-pirouettes in walk (one-hundred and eighty -180- degrees) are executed out of Collected walk with the collection being maintained throughout the exercise. When the Horse exits the half-pirouette it returns to the initial track without crossing the hind legs.

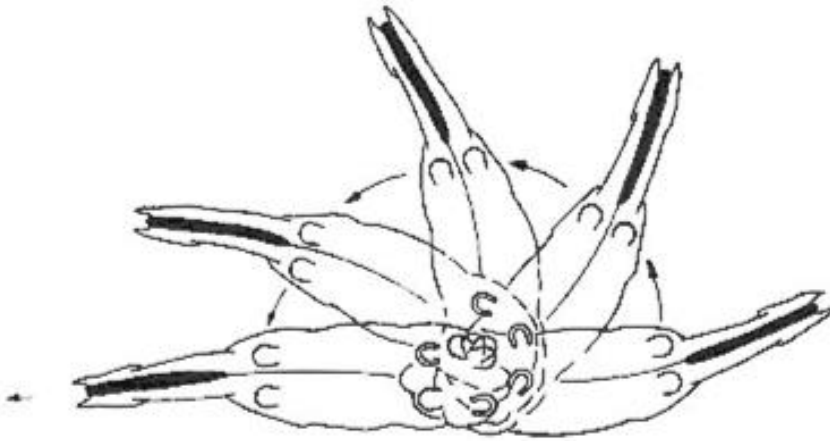

Half-pirouette in walk

9. Turn on the haunches from walk. For younger Horses that are still not able to show Collected walk the "turn on the haunches" is an exercise to prepare the Horse for collection. The "turn on the haunches" is executed out of Medium walk prepared by half halts to shorten the steps a little and to improve the ability to bend the joints of the hindquarters. The Horse does not halt before or after the turn. The "turn on the haunches" can be executed on a larger radius (approx. ½m) than the pirouette in walk, but the demands of the training scale concerning rhythm, contact, activity and straightness are the same.
10. Turn on the haunches from halt to halt (one-hundred and eighty -180- degrees). To maintain the forward tendency of the movement one (1) or two (2) forward steps at the beginning of the turn are permitted. The same criteria apply as for the turn on the haunches from walk.

ARTICLE 414 THE PASSAGE

1. Passage is a measured, very collected, elevated and cadenced trot. It is characterised by a pronounced engagement of the hindquarters, a more accentuated flexion of the knees and hocks, and the graceful elasticity of the movement. Each diagonal pair of legs is raised and returned to the ground alternately, with cadence and a prolonged suspension.
2. In principle, the height of the toe of the raised forefoot should be level with the middle of the cannon bone of the other supporting foreleg. The toe of the raised hind foot should be slightly above the fetlock joint of the other supporting hind leg.
3. The neck should be raised and gracefully arched with the poll as the highest point and the nose line close to the vertical. The Horse should remain light, and soft "on the bit" without altering the cadence. The impulsion remains lively and pronounced.
4. Irregular steps with the hind or front legs, swinging the forehand or the hindquarters from one (1) side to the other, as well as jerky movements of the forelegs or the hind legs, dragging the hind legs or double beat in the moment of suspension are serious faults.

The aim of passage is too demonstrate the highest degree of collection, cadence and suspension in the trot.

ARTICLE 415 THE PIAFFE

1. Piaffe is a highly collected, ~~cadenced~~ elevated, rhythmical diagonal movement giving the impression of remaining in place. The Horse's back is supple and elastic. The hindquarters are lowered; the haunches with active hocks are well engaged, giving great freedom, lightness and mobility to the shoulders and forehand. Each diagonal pair of legs is raised and returned to the ground alternately, with spring and ~~an even cadence~~ regularity.

- 1.1. In principle, the height of the toe of the raised forefoot should be level with the middle of the cannon bone of the other supporting foreleg. The toe of the raised hind foot should reach just above the fetlock joint of the other supporting hind leg.
- 1.2. The neck should be raised and gracefully arched, with the poll as the highest point. The Horse should remain "on the bit" with a supple poll, maintaining soft contact. The body of the Horse should move in a supple, ~~cadenced~~ and harmonious movement.
- 1.3. Piaffe should show true commitment and must always be animated by a lively ~~impulsion-activity~~ and characterised by perfect balance. While giving the impression of remaining in place, there may be a visible inclination to advance, this being displayed by the Horse's eager acceptance to move forward as soon as it is asked.
- 1.4. Moving even slightly backwards, irregular or jerky steps with the hind or front legs, no clear diagonal steps, crossing either the fore or hind legs, or swinging either the forehand or the hindquarters from one (1) side to the other, getting wide behind or in front, moving too much forward or double-beat rhythm are all serious faults.

The aim of piaffe is to demonstrate the highest degree of collection while giving the impression of remaining in place.

ARTICLE 416 THE IMPULSION / THE SUBMISSION

1. Impulsion is the term used to describe the transmission of an eager and energetic, yet controlled, propulsive energy generated from the hind quarters into the athletic movement of the Horse. Its ultimate expression can be shown only through the Horse's soft and swinging back guided by gentle contact with the Athlete's hand.
 - 1.1. Speed, of itself, has little to do with impulsion; the result is more often a flattening of the paces. A visible characteristic is a more pronounced articulation of the hind leg, in a continuous rather than staccato action. The hock, as the hind foot leaves the ground, should first move forward rather than being pulled upwards, but certainly not backwards. A prime ingredient of impulsion is the time the Horse spends in the air rather than on the ground. Impulsion is, therefore, seen only in those paces that have a period of suspension.
 - 1.2. Impulsion is a precondition for a good collection in trot and canter. If there is no impulsion, then there is nothing to collect.
2. Submission does not mean subordination, but an obedience revealing its presence by a constant attention, willingness and confidence in the whole behaviour of the Horse as well as by the harmony, lightness and ease it is displaying in the execution of the different movements.

The degree of the submission is also demonstrated by the way the Horse accepts the bit, with light and soft contact and a supple poll. Resistance to or evasion of the Athlete's hand, being either "above the bit" or "behind the bit" demonstrate lack of submission. The main contact with the Horse's mouth must be through the snaffle bit.

- 2.1. Putting out the tongue, keeping it above the bit or drawing it up altogether, as well as grinding the teeth or agitation of the tail, are mostly signs of nervousness, tension or resistance on the part of the Horse and must be taken into account by the Judges in their marks for every movement concerned, as well as in the collective mark..
- 2.2. The first thought when considering submission is willingness, that the Horse understands what is being asked of it and is confident enough in the Athlete to react to the aids without fear or tension.

- 2.3. The Horse's straightness, uphill tendency and balance enable it to stay in front of the Athlete's legs and go forward into an accepting and self-carrying contact with the bit. This is what really produces the picture of harmony and lightness.
The fulfilling of the main requirements/movements of a Dressage test is the main criterion for submission.

ARTICLE 417 THE COLLECTION

The aim of the collection of the Horse is:

- a) To further develop and improve the balance and equilibrium of the Horse, which has been more or less displaced by the additional weight of the Athlete.
- b) To develop and increase the Horse's ability to lower and engage its hindquarters for the benefit of the lightness and mobility of its forehand.
- c) To add to the "ease and carriage" of the Horse and to make it more pleasurable to ride.

Collection is developed through the use of half-halts and the use of lateral movements shoulder-in, travers, renvers and half pass.

Collection is improved and achieved by the use of the seat and legs and containing hands to engage the hind legs. The joints bend and are supple so that the hind legs can step forward under the Horse's body.

However, the hind legs should not be engaged so far forward under the Horse, that they shorten the base of support excessively, thereby impeding the movement. In such a case, the line of the back would be lengthened and raised too much in relation to the supporting base of the legs, the stability would be impaired and the Horse would have difficulty in finding a harmonious and correct balance.

On the other hand, a Horse with an over-long base of support, which is unable or unwilling to engage its hind legs forward under its body, will never achieve acceptable collection, characterised by "ease and carriage" as well as a lively impulsion originating from the activity of the hindquarters.

The position of the head and neck of a Horse at the collected paces is naturally dependent on the stage of training and, to some degree, on its conformation. It is distinguished by the neck being raised without restraint, forming a harmonious curve from the withers to the poll, which is the highest point, with the nose slightly in front of the vertical. At the moment the Athlete applies the aids to obtain a momentary and passing collecting effect, the head may become more or less vertical. The arch of the neck is directly related to the degree of collection.

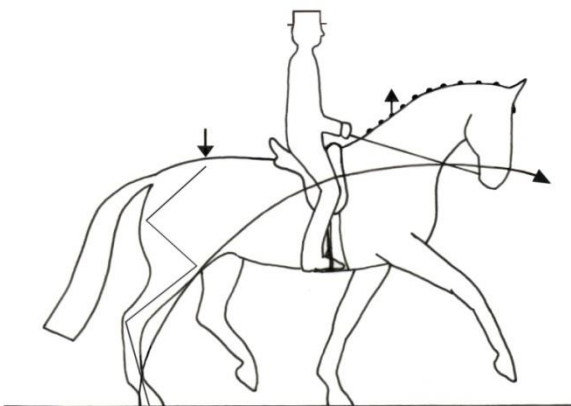

ARTICLE 418 THE POSITION AND AIDS OF THE ATHLETE

1. All the movements should be obtained with imperceptible aids and without apparent effort of the Athlete. The Athlete should be well-balanced, elastic, sitting deep in the centre of the saddle, smoothly absorbing the movement of the Horse with the loins and hips, supple thighs with the legs steady and stretched well down. The heels should be the lowest point. The upper part of the body should be tall and supple. The contact should be independent from the Athlete's seat. The hands should be carried steadily close together, with the thumb as the highest point and a straight line from the supple elbow through the hand to the Horse's mouth. The elbows should be close to the body. All of these criteria enable the Athlete to follow the movements of the Horse smoothly and freely.
2. The effectiveness of the Athlete's aids determines the precise fulfilment of the required movements of the tests. There shall always be the impression of a harmonious co-operation between Horse and Athlete.
3. Riding with both hands is obligatory at FEI Dressage Events. When leaving the arena at a walk on long rein, after having finished the test the Athlete may, at their own discretion, ride with only one (1) hand. For Freestyle tests, see also Directives for Judges – Freestyle tests and Directives for assessing the degree of difficulty in a Freestyle test available at www.fei.org.

3.1 Apart from the halt and salute, where the athlete must take the reins in one hand, riding with the reins in both hands is obligatory at FEI Dressage Events, but a discreet 'pat on the neck' for a well performed exercise, or for reassurance, is perfectly acceptable (as is the situation of an athlete needing to wipe a fly from their eye, or other situations such as adjusting clothing, saddle pads etc).

However, if the rider intentionally takes the reins into one hand in order to use either the reins or the other hand to produce more impulsion from the horse, or to promote applause from the spectators during the test, it will be considered a fault and will be reflected in the mark for both the movement and the collective mark.

For the Freestyle tests, see also Directives for Judges - Freestyle tests and Directives for assessing the degree of difficulty in a Freestyle.

4. The use of the voice or clicking the tongue repeatedly is a fault. See article 430.6.2.

CHAPTER II DRESSAGE EVENTS

ARTICLE 419 OBJECT OF INTERNATIONAL DRESSAGE EVENTS

The FEI established an International Dressage Event in 1929 in order to preserve the Equestrian Art from the abuses to which it can be exposed and to preserve it in the purity of its principles, so that such principles of the discipline could be handed down intact to future generations of Athletes.

ARTICLE 420 CATEGORIES OF INTERNATIONAL DRESSAGE EVENTS

1. In conformity with the FEI GRs, the International Dressage Events are divided into CDI1* to CDI5*, CDI-Ws, CDIO2* to CDIO5*, CDIU25, CDIOU25, CDIY, CDIOY, CDIJ, CDIOJ, CDICH, CDIOCh, CDIP, CDIOP, CDIYH, CDIAM, FEI Championships, Regional and Olympic Games which must be held according to the Rules given in the following articles, unless otherwise stated in the pre-emptive Rules for any of these Events, such as the Olympic Games or Paralympic Games.

2. National Events (CDN). Refer to FEI GRs.

This rule does not apply to foreign Athletes (Athletes Living outside Their Country of Nationality as defined in the FEI GRs) who are domiciled for part of the year in the host country and hold a guest licence with the host NF.

3. CDI-Ws (Qualifiers and Final). Events, where a FEI World Cup™ Competition is held are indicated by the addition of the letter "W". Also refer to the FEI World Cup™ Rules for Dressage.

3.1 In case of date clashes, CDI-W qualifiers will prevail over CDIs 4* and above in the same league.

3.2 No CDI5* or above is allowed on the same dates as the FEI World Cup™ Dressage Final. In principle there may be no CDI-W two (2) weeks prior to the FEI World Cup™ Dressage Final.

4. In CDI/CDI-W/CDIU25/CDIY/CDIJ/CDIP/CDICH/CDIAM no unofficial team Competitions are allowed. For official team Competitions, refer to CDIOs.

4.1 A CDIY, CDIJ, CDIP, CDICH, CDIU25 is an International Event open to individual Athletes from the host country and from an unrestricted number of foreign countries.

No Team Competition may be held during a CDI for Youth Categories.

4.2 In order to organise a CDI5*, an OC must first have organised a CDI3*/CDI4* with positive official FEI reports.

5. CDIOs

5.1 Eligibility of Athletes:

5.1.1 In principle CDIOs are open to Athletes from an unlimited number of foreign nations (see also FEI GRs).

5.1.2 In order for a CDIO to receive its status, at least six (6) teams, including host NF, must be invited (one -1- team per NF) and at least three (3) teams must have participated. For Nations Cup Events, please refer to the published FEI Dressage Nations Cup Rules.

5.2 Priority. CDIO2* to 5* take precedence over all CDI Events in accordance with the FEI GRs. CDIO Events on the same Continent must not clash.

5.3 Team Competitions:

- 5.3.1 To qualify as a team Competition, an official Team Competition must be scheduled. The teams must consist of a maximum of four (4) and of a minimum of three (3) Athletes of the same nationality. No reserve combinations are allowed. CDI/Os3* or higher may use the new Olympic format. Team compositions for Youth classes are defined in the relevant annexes.
6. FEI Championships. See Chapter V of the Dressage Rules.
7. Regional Games. The Rules for these Events must be approved by the General Assembly of the FEI.
8. Olympic Games. See Regulations for the Equestrian Events at the Olympic Games published separately on the FEI Website.
9. There may be no FEI World Cup™ Dressage Competitions, CDI/CDIO5* or CDI/CDIO4* Events two (2) weeks prior to the Olympic Games, World Championships as well as to Continental CHs on the same Continent.

ARTICLE 421 TESTS

Each Competition has its own test. The Official Dressage tests are published under the authority of the FEI and can in no case be modified or simplified without the approval of the FEI. These tests are as follows:

1. Tests for Young Horses:
 - 1.1 Tests for four (4) year-old Horses (only for use at National Events).
 - 1.2 Tests for five (5) year-old Horses.
 - 1.3 Tests for six (6) year-old Horses.
 - 1.4 Tests for seven (7) year-old Horses.
2. Prix St. Georges - Test of medium standard

This test represents the medium stage of training. It includes exercises to show the Horse's submission to all the demands of the execution of classical equitation and a standard of physical and mental balance and development which will enable it to carry the exercises out with harmony, lightness and ease.

3. Intermediate I - Test of advanced medium standard

The object of this test is to lead Horses on, progressively and without harm to their mind and body, from the correct execution of Prix St Georges to the more demanding exercises of the Intermediate Competition Number II.

4. Intermediate A
5. Intermediate B
6. Intermediate II - Test of advanced standard

The object of this test is to prepare the Horses for the Grand Prix.

7. Grand Prix – Test of the highest standard

The Grand Prix is a Competition of the highest level, which brings out the Horse's perfect lightness, characterised by the total absence of resistance and the complete development of collection and impulsion, which includes all the school paces and all the fundamental movements.

7.1 Short Grand Prix – Test of the same standard as the Grand Prix. The Short Grand Prix is used in all World Cup Events as referred to in the relevant Rules.

8. Grand Prix Special - Test of the same standard as Grand Prix

This is a Competition of the same level as Grand Prix, where especially the transitions are a matter of great importance.

9. The Freestyle Test

This is a Competition of artistic equitation to music at Young Riders, Junior, Pony Riders, Intermediate I or Grand Prix level. It includes all the school paces and the fundamental movements as in the test of the same level. The Athlete is, however, absolutely free in the form and manner of the presentation they choose within a fixed time in accordance with the technical freestyle rules. The test should clearly show the unity between Athlete and Horse as well as harmony in all the movements and transitions.

9.1 Degree of Difficulty: The FEI Freestyle System must be used at Championships, Games, Finals and WEL CDI-W in Grand Prix Level. The system may be used at CDIs/CDIOs, at Grand Prix level competitions at the discretion of the OC. Whenever used, it must be announced in the FEI approved Schedule. See FEI Freestyle System appliance guidelines published on the FEI Website.

10. Other Tests. No tests other than the Official FEI Dressage tests may be used at FEI Dressage Events. If an OC would like to try out a new test or competition format, this may be done as Show class(es) outside the CDI but included in the Schedule. Any such test requires approval of the FEI.

11. The Official Dressage tests for Young Riders, Juniors, Pony Riders and Children are given in the specific Regulations and published by the FEI. Any of these tests may only be used for Senior Competitions on prior approval by the FEI. Conditions for participation are as specified under Article 422 of the Dressage Rules. The same applies for the FEI World Dressage Challenge Tests.

ARTICLE 422 CONDITIONS OF PARTICIPATION

1. Definitions:

1.1 Athletes. International Senior Dressage Events are open to Athletes from the calendar year in which they reach their 16th birthday.

1.2 Para-Equestrian Athletes. Para-Equestrian Athletes are allowed to compete in FEI Dressage Competitions using compensating aids in accordance with their respective degree of disability as defined by the FEI Para-Equestrian Master list and the Standard Compensating Aids (see FEI Para Dressage Rules).

1.3 Separate Competitions for men and women are not allowed.

1.4 Horses of any origin may take part in International Dressage Events provided they are a minimum of six (6) years of age. Junior tests: minimum six (6) years; Young Riders/Prix St. Georges/Intermediate I: minimum seven (7) years; tests above Intermediate I: minimum eight

(8) years. Horses at all levels must have a height at the withers exceeding one meter and forty eight centimetre (1.48 m) without shoes, with the exception of Children’s events (CDI-Ch) where Ponies are allowed. See also specific Competitions/Events for five (5), six (6) and 7 (seven) year old young Horses.

The age of Horses is counted from 1st January of the year of birth (1st August for Southern Hemisphere). If the country of birth is not known, then the formula for the northern hemisphere will be used.

A = Age (in Years)

C = Current Year

B = Year of Birth

In the northern hemisphere the age of the Horse is calculated as follows (standard determination of the age):

$$A = C - B$$

In the southern hemisphere the age changes 01 August (instead of 01 January) and is calculated as follows:

Dressage		Current Date	
		Before and until 31 July	From and after 01 Aug
Born	Before 31 July	$A = C - B$	$A = C - B + 1$
	After 01 Aug	$A = C - B - 1$	$A = C - B$

- 1.5 Horses may only take part in one (1) Competition per day at International Dressage Events and may not start in a National Dressage Competition/Event from the start time of the Horse inspection until the day after completing their last international Competition at the same Event.
2. Levels of Competition:
 - 2.1. Prix St. Georges. This Competition is open to all Horses
 - 2.2. Intermediate I. This Competition is either open to all Horses or, if the Intermediate I has been scheduled after a Prix St. Georges the Intermediate I must be open to but not compulsory for minimum six (6) best Athlete/Horse combinations who qualified in the Prix St-Georges competition.
 - 2.3. Intermediate I Freestyle. This Competition can only be scheduled after a Prix St-Georges or Intermediate I Competition. The Intermediate I Freestyle shall be open to but not compulsory for the six (6) (minimum) to fifteen (15) (maximum including ties for 15th place) best Athlete/horse combinations who qualified in the Prix St. Georges or Intermediate I competition. It is the discretion of the OC to make the Freestyle mandatory or not. This must be stated in the Schedule.
 - 2.4. Intermediate A. This competition is open to all Horses.
 - 2.5. Intermediate B. This competition is either open to all Horses or, if the Intermediate B has been scheduled after an Intermediate A, the Intermediate B must be open to but not compulsory for minimum the six (6) best Athlete/horse combinations who qualified in the Intermediate A competition.
 - 2.6. Intermediate A/B Freestyle. This Competition can only be scheduled after an Intermediate A or Intermediate B. The Intermediate A/B Freestyle shall be open to but not compulsory for the six (6) (minimum) to fifteen (15) (maximum including ties for 15th place) best Athlete/horse combinations who qualified in the Intermediate A or Intermediate B. It is at the discretion of the OC to make the Freestyle mandatory or not. This must be stated in the Schedule.

- 2.7 Intermediate II. This Competition is either open to all Horses or, if the Intermediate II has been scheduled after an Intermediate A or B, the Intermediate II must be open to but not compulsory for the minimum six (6) (minimum) best Athlete/horse combinations who qualified in the Intermediate A or B competition
- 2.8 Grand Prix. This Competition is either open to all Horses or, if the Grand Prix is scheduled after an Intermediate II and considered as a Final, at the discretion of the OC, the Grand Prix may be open to all Horses or to the six (6) minimum to fifteen (15) maximum (including ties for 15th place) best Athlete/Horse combinations who qualified in the Intermediate II. The option chosen by the OC must be stated in the schedule and it is at the discretion of the OC to make the Grand Prix mandatory or not.
- 2.9 Grand Prix Special. A Grand Prix Special can only be scheduled after a Grand Prix Competition. In a CDI3* and above, the Grand Prix Special must be scheduled to be open to the six (6) (minimum) to fifteen (15) (maximum including ties for 15th place) best Athlete/Horse combinations who declared and qualified in the Grand Prix Competition. If fewer than six (6) combinations are qualified they may all start. If there are thirty (30) or more combinations in the qualifying Grand Prix, the OC is obliged to have ~~a minimum of~~ fifteen (15) starters in the Grand Prix Special. Athletes who declare their intention to qualify for the Grand Prix Special are obliged to compete if qualified. Athletes may start one (1) Horse only. For CDIOs, FEI Championships and Olympic Games, see Articles 449 and 456 of the Dressage Rules. For Athlete/Horse combinations qualified, it is mandatory to participate. In cases of legitimate cancellation due to illness, etc. the next Athlete/Horse combination will be invited to move up from the Grand Prix.
- 2.10 Grand Prix Freestyle. A Grand Prix Freestyle Test can only be scheduled after a Grand Prix Competition. At CDI-Ws a Grand Prix Freestyle Test is obligatory. The Grand Prix Freestyle shall be open to the six (6) (minimum) to fifteen (15) (maximum including ties for 15th place) best Athlete/Horse combinations who qualified in the Grand Prix Competition. If fewer than six (6) combinations are qualified they may all start. If there are thirty (30) or more combinations in the qualifying Grand Prix, the OC is obliged to have ~~a minimum of~~ fifteen (15) starters in the Grand Prix Freestyle. Athletes who declare their intention to qualify for the Grand Prix Freestyle are obliged to compete if qualified. Athletes may start one (1) Horse only. For CDIOs and FEI Championships as well as Olympic Games, see Articles 449 and 456 of the Dressage Rules. For Athlete/Horse combinations qualified, it is mandatory to participate. In cases of legitimate cancellation due to illness or other unforeseen circumstances, the next Athlete/Horse combination will move up from the Grand Prix.
- 2.11 Consolation Competition. Horses not qualified for the Grand Prix Special or the Grand Prix Freestyle Test and Horses who's Athletes had opted for the Grand Prix Consolation beforehand may start in a Consolation Competition (Intermediate II or Grand Prix if scheduled). Consolation Competitions if scheduled will however never grant ranking points for the FEI World Dressage Ranking List or any qualification points for FEI Championships or Olympic Games and the prize money must be of lower level than the WDRL qualifying Competitions. Scores awarded in Consolation Competitions do not count for the purpose of achieving eligibility scores.
- 2.11.1 Consolation Competitions may be scheduled in small and medium tour.
- 2.11.2 A Consolation Competition must be judged by three (3) Judges only and must be clearly marked in the Schedule and results lists.
- 2.12 An Athlete who does not participate without legitimate reasons in a competition where the participation is mandatory, will lose their placing and prize money from the previous Competition(s) in the Event and will be disqualified.
3. Competition Protocols:
- 3.1 Qualification score for all Freestyle tests and Grand Prix Special.

A Horse must earn a minimum score of sixty percent (60%) in the qualifying Competition, in order to be eligible to start in a Freestyle of all levels or a Grand Prix Special Competition.

3.2 Number of Horses per Athlete per Competition.

3.2.1 At all CDI Events, the number of Horses each Athlete may ride in each Competition, except for Freestyle tests and the Grand Prix Special in which each Athlete may ride only one (1) Horse, is left to the discretion of the OC.

3.2.2 This rule is applicable also for CDI Os, with the exception of the Grand Prix, in which each Athlete may ride only one (1) Horse (see also Article 448 of the Dressage Rules.).

3.2.3 Under special circumstances, in CDIs where there are fewer than fifteen (15) Athlete/Horse combinations entered and starting in the qualifying competition, OCs may request special permission from the FEI to allow Athletes with two (2) Horses in the qualifying competition to go forward to the Freestyle competition. If permission is granted, both Horses will receive WDRL points. The same conditions apply for the Grand Prix Special or other competitions scheduled between the qualification competition and the Freestyle. Such special permission must be stated in the approved Schedule.

3.2.4 However, when the OC in the Schedule for the Event in some Competitions allows the Athletes to ride more than one (1) Horse, it is advisable to make a provision that this permission may be withdrawn if too many nominated entries are sent in later on, before the closing date.

3.2.5 If the Athlete qualifies with two (2) Horses for the Freestyle test or any test that is considered as a Final and only one (1) Horse is allowed to participate, the Athlete may select which Horse to start.

3.3 Opting. In CDIs (except youth categories) with 3 competitions in the Tour, the Athletes must state, at the latest at the date of definite entry, for which of the two (2) following Competitions they wish to qualify. Athletes may give a 1st and 2nd choice if the OC so allows (e.g. Athlete will opt for Grand Prix Freestyle as 1st choice and Grand Prix Special as 2nd choice. The OC may also place the Athletes in the competitions based on the results of the first competition). If following the conclusion of the first Competition, any of the two next competitions is oversubscribed, the Athlete may then start in the other competition instead). Participation is, however, only possible in one (1) of the Competitions with the same Horse, and their original choice of Competition cannot be changed if there is space in that Competition.

3.3.1 In a CDI3*, If a GP Consolation is scheduled, the Athlete may opt to go from the Grand Prix to the GP Consolation, at the latest at the date of definite entry. For CDI3* and above outside Europe and North America, an Athlete may ride in three Grand Prix classes (Grand Prix, Grand Prix Special and Grand Prix Freestyle) but the Grand Prix Special and Grand Prix Freestyle are only open to the six (6) (minimum) to fifteen (15) (maximum including ties for 15th place) best Athlete/Horse combinations who qualified in the Grand Prix Competition.

3.4. Spreading of Competition over two (2) days. If the number of Athletes in a Competition exceeds approximately forty (40), the OC must spread this Competition over two (2) days or divide the Competition into two (2) separate Competitions. In extraordinary cases with more than eighty (80) Athletes, the FEI will make the final decision how to solve the situation.

Any eventual alteration of the foreseen time-table should be made in agreement with FEI.

3.5 Selection of Competitions. At any Event, the same Athlete/Horse combination can, however, only take part in Competitions of the same level, as defined below

Small Tour: Prix St. Georges – Intermediate I – Intermediate I Freestyle.

Medium Tour: Intermediate A – Intermediate B– Intermediate II; Intermediate A/B Freestyle.

Big Tour: Intermediate II – Grand Prix – Grand Prix Special – Grand Prix Freestyle.

3.6 Schooling of Horses/Ponies.

3.6.1 No one other than the Athlete may ride the Horse/Pony they are entered with, as of the official opening of the stables according to the FEI approved schedule as well as for the duration of the whole Event under penalty of disqualification (see Art. 429.10.4). This means, for instance, that a groom mounted in the saddle may walk the Horse/Pony on a long, safe rein and that lunging and verbal assistance from the ground from the trainer or their representative is permitted. An exception to this rule may only be granted under extraordinary circumstances in writing by the FEI or the President of the Ground Jury.

3.6.2 For use of whips, refer to Article 428 of the Dressage Rules. Under no circumstances is it permitted to school the Horses in other areas than the official training arenas. No schooling is permitted in any area which cannot be supervised by the Stewards.

3.6.3 Horses may not leave the stables, the Competition area, or the areas supervised by Stewards for any purpose unless authorised by a recognised FEI Official of the Event or a Veterinarian acting in the interest of the health and welfare of the Horse.

3.7 Certificates of Capability. For the Olympic Games and for FEI World and European Championships, a confirmation of capability for each Athlete/Horse combination is required from NFs for all entered combinations based on results at CDI3*/CDI4*/CDI5* and CDI Os. For FEI World Championships and Continental Championships on Grand Prix level, results from CDI2* outside Europe and North America may count under specific conditions. Qualification standards will be established from case to case for all FEI World and European Championships and Olympic Games and shall be published separately by the FEI. Such standards, when published, shall thereby be regarded as being part of the Dressage Rules. Certificate of Capability for other Championships and Games may be requested according to the requirements of the Event.

3.8 Scheduling possibilities at Senior Dressage Events (not exhaustive)

CDIYHs:

- Preliminary Dressage Test for five (5)-year old Horses – Dressage Test for five (5)-year old Horses – Final.
- Preliminary Dressage Test for six (6)-year old Horses – Dressage Test for six (6)-year old Horses – Final.
- Preliminary Dressage Test for seven (7)-year old Horses – Dressage Test for seven (7)-year old Horses – Final.

Small Tour:

- Prix St. Georges.
- Prix St. Georges - Intermediate I.
- Prix St. Georges - Intermediate I Freestyle
- Prix St. Georges - Intermediate I – Intermediate I Freestyle.
- Prix St. Georges - opting for Intermediate I or Intermediate I Freestyle.
- Intermediate I.
- Intermediate I – Intermediate I Freestyle.

Medium Tour:

- Intermediate A
- Intermediate B
- Intermediate A - Intermediate B
- Intermediate A - Intermediate II
- Intermediate B - Intermediate II
- Intermediate A - Intermediate B – Intermediate II
- In addition, an Intermediate A/B Freestyle may be organised at the discretion of the OC (maximum three tests allowed, opting will be possible if three tests are scheduled).

Big Tour:

- Intermediate II
- Intermediate II – Grand Prix
- Intermediate II – Grand Prix – Grand Prix Freestyle or Grand Prix Special
- Grand Prix
- Grand Prix – opting for Grand Prix Special or Grand Prix Freestyle.
- Grand Prix – Grand Prix Special.
- Grand Prix – Grand Prix Freestyle
- Grand Prix – Grand Prix Special - Grand Prix Freestyle.
- Nations Cup Formula at CDIO: Grand Prix and Grand Prix Special or Grand Prix Freestyle.
- Championship Formula at CDIO and FEI Championships:
Grand Prix – Grand Prix Special – Grand Prix Freestyle

Consolation Competition (Big Tour):

- Intermediate II
- Grand Prix

CDIAM (Amateur): Senior Tests up to and including FEI Grand Prix, excluding Grand Prix Special and Grand Prix Freestyle.

A separate small tour for Horses age seven (7)-nine (9) years may be scheduled under the condition that a normal, open small tour is also scheduled in CDI1*. A separate medium tour for Horses age eight (8)-ten (10) years may be scheduled under the condition that a normal, open medium tour is also scheduled in CDI2*. A separate big tour for Horses age eight (8)-ten (10) years may be scheduled under the condition that a normal, open big tour is also scheduled in CDI3*/CDI4*/CDI5*. The big tour with age limit will not count for the World Ranking List.

3.9 A Derby with change of Horses may be organised. It shall be open to and compulsory for the three (3) best Athlete/Horse combinations from one (1) or two (2) (to be specified in the Schedule) qualifying Competitions. No change of saddle, bridle and bit is permitted. The Horses must always be ridden in the same saddle, bridle and bit. Each Horse will be started by each Athlete, first by its own Athlete, then by the other Athletes by draw. This class will not count for the World Ranking list. Athletes may start with another horse that has not necessarily been ridden by the same Athlete in a qualifying competition.

4. **Scheduling possibilities at Youth Events:**

4.1 **Young Riders**

4.1.1 The Official FEI Dressage tests for Young Riders are as follows:

- (i) Preliminary Competition Test Open
- (ii) Team Competition Test Open
- (iii) Individual Competition Test Open
- (iv) Young Riders Freestyle Test Six (6) to eighteen (18) best from Individual Competition, including ties for the highest placing

The tests two-four (2-4) are compulsory for CDIOYs and FEI Championships and recommended for all other International Young Riders Dressage Events. These tests must be carried out entirely from memory.

4.1.2 **The Preliminary Competition Test** is optional. Should a Preliminary Dressage test not be scheduled there must be time allocated for Athletes to familiarise with the main arena before the Team test.

4.1.3 **The Team Competition Test.** The Team test also serves as the first individual qualification Competition for the Individual Competitions.

4.1.4 **The Individual Competition Test.** This Competition is open to all Athletes who previously completed the Team Competition.

4.1.5 **Young Riders Freestyle Test.** This Competition is limited to the six (6) to eighteen (18) best Athlete/Horse combinations who qualified in the Individual Competition including those who tie for the highest qualified place. Athletes may start one (1) Horse.

It is the discretion of the OC to make the Freestyle mandatory or not. This must be stated in the Schedule.

4.1.6 **Consolation Competition.** Athletes/Horses not qualified for the Young Rider Freestyle Test may start in a consolation test if scheduled. Consolation Competitions (Individual competition Test or Young Rider Freestyle) if scheduled should however only have prizes in kind or the prize money shall be less than for the qualifying Competition tests. A Consolation Competition must be clearly marked in the Schedule and result lists and may only be judged by three (3) Judges.

4.2 Juniors

4.2.1 The Dressage Tests for Juniors are as follows:

- | | | |
|-------|------------------------------|---|
| (i) | Preliminary Competition Test | Open |
| (ii) | Team Competition Test | Open |
| (iii) | Individual Competition Test | Open |
| (iv) | Junior Freestyle Test | Six (6) to eighteen (18) best from Individual Competition, including ties for the highest placing |

The tests two-four (2-4) are compulsory for CDIOJs and FEI Championships and recommended for all other International Junior Dressage Events. These tests must be carried out entirely from memory.

4.2.2 **The Preliminary Competition Test** is optional. Should a Preliminary test not be scheduled, there must be time allocated for Athletes to familiarize with the main arena before the Team test.

4.2.3 **The Team Competition Test:** The Team test also serves as the first individual qualification Competition for the Individual Competition.

4.2.4 **The Individual Competition Test:** This Competition is open to all Athletes who completed the Team Competition.

4.2.5 **Junior Freestyle Competition.** This Competition is limited to the six (6) to eighteen (18) best Athlete/Horse combinations who qualified in the Junior Individual Competition including those who tie for the highest qualified place. Athletes may start one (1) Horse.

It is the discretion of the OC to make the Freestyle mandatory or not. This must be stated in the Schedule.

4.2.6 **Consolation Competition.** Athletes/Horses not qualified for the Junior Freestyle Test may start in a Consolation Competition (Individual Competition Test or Junior Freestyle) if scheduled. Consolation Competitions if scheduled should however only have prizes in kind or the prize money shall be of lower level than the qualifying Competition tests. A Consolation Competition must be clearly marked in the Schedule and result lists and may only be judged by three (3) Judges.

4.3 Children

4.3.1 The Dressage tests for Children are as follows:

- | | | |
|-----|--------------------------------|------|
| (i) | Preliminary Competition Test A | Open |
|-----|--------------------------------|------|

- (ii) Preliminary Competition Test B Open
- (iii) Team Competition Test Open
- (iv) Individual Competition Test Six (6) to eighteen (18) best from Team Competition, including ties for the highest placing.

4.3.2 The tests two-four (2-4) are compulsory for CDI/OCs and FEI Championships and recommended for all other International Children Dressage Events. These tests must be carried out entirely from memory.

4.3.3 **The Preliminary Competition Test** is optional. Should a Preliminary Dressage test not be scheduled there must be time allocated for Athletes to familiarise with the main arena before the Team test.

4.3.4 **The Team Competition Test.** The Team test also serves as the qualification Competition for the Individual Competition.

4.3.5 **The Individual Competition Test.** This Competition is limited to the six (6) to eighteen (18) best Athlete/Horse combinations who qualified in the Team Competition test including those who tie for the highest qualified place. Athletes may start one (1) Horse.

It is the discretion of the OC to make the Individual Competition Test mandatory or not. This must be stated in the Schedule.

4.3.6 **Consolation Competition.** Athletes/Horses not qualified for the Children Individual Test may start in a consolation test if scheduled. Consolation Competitions (Team Competition Test or Individual Competition Test) if scheduled should however only have prizes in kind or the prize money shall be less than for the qualifying Competition tests. A Consolation Competition must be clearly marked in the Schedule and result lists and may only be judged by three (3) Judges.

4.4 Pony Riders

4.4.1 The Dressage tests for Pony Riders are as follows:

- (i) Pony Riders Preliminary Competition Test (Optional) Open
- (ii) Pony Riders Team Competition Test Open
- (iii) Pony Riders Individual Competition Test Open
- (iv) Pony Riders Freestyle Competition Test Six (6) to eighteen (18) best from Individual Competition, including ties for the highest placing

The tests two-four (2-4) are compulsory for CDIOPs and FEI Championships and recommended for all other International Pony Riders Dressage Events. These tests must be carried out entirely from memory.

4.4.2 **The Preliminary Competition Test** is optional. Should a Preliminary Dressage test not be scheduled there must be time allocated for Athletes to familiarise with the main arena before the Team test.

4.4.3 **The Team Competition Test.** The Team test also serves as the first individual qualification Competition for the Individual Competitions.

4.4.4 **The Individual Competition Test.** This Competition is open to all Athletes who completed the Team Competition.

4.4.5 **Pony Riders Freestyle Test.** This Competition is limited to the six (6) to eighteen (18) best Athlete/Pony combinations who qualified in the Individual Competition including those who tie for the highest qualified place. Athletes may start one (1) Pony.

It is the discretion of the OC to make the Freestyle mandatory or not. This must be stated in the Schedule.

4.4.6 **Consolation Competition.** Athletes/Horses not qualified for the Pony Rider Freestyle Test may start in a consolation test if scheduled. Consolation Competitions (Individual Competition Test or Pony Riders Freestyle test) if scheduled should however only have prizes in kind or the prize money shall be less than for the qualifying Competition tests. A Consolation Competition must be clearly marked in the Schedule and result lists and may only be judged by three (3) Judges.

4.5 **U25**

4.5.1 The Dressage tests for U25 Riders are as follows:

- (i) Intermediate A Open
- (ii) Intermediate B Open
- (iii) Intermediate II Open
- (iv) Grand Prix 16-25 Open
- (v) Grand Prix Freestyle Six (6) (minimum) to fifteen (15) (maximum including ties for 15th place) best from Grand Prix

The tests three-five (3-5) are compulsory for CDI/U25s and FEI Championships and recommended for all other International U25 Riders Dressage Events. These tests must be carried out entirely from memory.

4.5.2 **The Intermediate II Test.** The Intermediate II test ~~also~~ serves as the first individual qualification Competition for the Grand Prix 16-~~2~~5 Competition.

4.5.3 **The Grand Prix 16-25 Test.** This Competition is open to all Athletes who completed the Intermediate II Competition.

4.5.4 **Grand Prix Freestyle Test.** This Competition is limited to the six (6) (minimum) to fifteen (15) (maximum including ties for 15th place) best Athlete/Horse combinations who qualified in the Grand Prix Competition. Athletes may start one (1) Horse.

It is the discretion of the OC to make the Freestyle mandatory or not. This must be stated in the Schedule.

4.5.5 **Consolation Competition.** Athletes/Horses not qualified for the Grand Prix Freestyle Test may start in a consolation test if scheduled. Consolation Competitions (Grand Prix or Grand Prix Freestyle) if scheduled should however only have prizes in kind or the prize money shall be less than for the qualifying Competition tests. A Consolation Competition must be clearly marked in the Schedule and result lists and may only be judged by three (3) Judges.

ARTICLE 423 INVITATIONS, ENTRIES AND SUBSTITUTIONS

1. Invitations

1.2 Must be extended through the respective NF. For CDI3*/CDI4*/CDI5* and CDIO 3*/CDIO4*/CDIO5* at least six (6) countries, including the host NF, plus three (3) reserve countries, with a minimum of one (1) Athlete each must be invited and accepted or twelve (12) countries with a minimum of one (1) Athlete each. For Events/Tours with up to 15 Athletes, the OC may invite minimum four (4) countries, including the host NF.

1.3 In each case an OC may never invite more home Athletes than foreign Athletes. The NFs concerned will make the final choice of the Athletes sent to an Event.

- 1.4 The draft Schedule must include a list of NFs invited to the Event plus reserve NFs, number of Athletes invited per NF and must be sent to the FEI at least ten (10) weeks before the date of the Event.

2. Personal Invitations / Wild Cards

- 2.1 For all CDIs the OC has a right to personally invite two (2) extra Athletes through their respective NF in addition to what is stated above.
- 2.2 For all CDI4*/CDI5*/CDI-Ws the FEI has the right to extend one (1) Wild Card entry in addition to invited NFs and Athletes.
- 2.3 For all CDI3* the FEI has the right to extend up to three (3) Wild Card entries for Athletes from developing NFs and to Athletes from NF not having received invitations but requiring Minimum Eligibility Standard scores for FEI Championships within a specific time limit.

OC Invitations and OC Wild Cards. These invitations (foreign and/or home Athletes) must be under the same conditions as for other participants and must in no way be directly or indirectly in connection with financial contribution. Pay Cards and Appearance fees are strictly prohibited as set forth in the FEI GRs.

FEI Wild Cards. Application for a FEI Wild Card should be made to the FEI Dressage Department through the Athlete's home NF, ~~two months~~ four weeks before the date closure of definite entries.

3. Entries

1. Entries for CDI Events must be made in accordance with the FEI GRs Art. 116.

Definite Entries. These entries must be made at the latest four (4) days preceding the beginning of the Event. These represent the final selection of Athletes and Horses that may participate in the Event. Substitutions of Athletes and/or Horses may only be made in accordance with these rules.

Entries for FEI Championships and FEI World Equestrian Games must be made in accordance with the FEI GRs Art. 116.

2. Athletes who withdraw after the date of definite entry or are no-shows, will be liable to reimburse the OC for the financial loss incurred by the OC (i.e. stabling and hotel expenses) as a result of this. In the absence of a satisfactory explanation, NFs having made entries for Athletes who do not show at the Event may be fined by the FEI. In such case, the OC has the right to charge all actual costs relating to the "no-shows" to the responsible NF.

4. Substitutions

- 4.1 Substitutions: (except FEI Championships and Games):
Following receipt of definite entries, substitution of Horse(s) and Athlete(s) may be made with the agreement of the OC. The OC must print in the Schedule the latest date for substitution of Horse(s) and Athlete(s), which may never be later than two (2) hours before the Horse inspection.
- 4.2 Substitutions for FEI Championships and FEI Games.
Refer to GRs and specific Regulations

ARTICLE 424 DECLARATION OF STARTERS

For Team competitions, except when stated otherwise in specific Rules, the following rules apply:

1. Declaration of starters should be done no later than one (1) hour after the Horse Inspection. The exact time of the draw should be published in the Schedule.
- 2.1 In the event of an accident or illness of an Athlete and/or Horse declared as starter, this Athlete and/or Horse may, up to two (2) hours before the start of the Competition and on production of a certificate from the doctor and/or the FEI Veterinary Delegate, after approval of the Ground Jury, be replaced by another Athlete and/or another Horse formally entered and, where required, who are also qualified. The Athlete or Horse withdrawn may not then start either as a member of a team or as an individual.

The replacement Athlete shall start first in the Competition and the rest of the starting times shall be adjusted accordingly for the other Athletes.
- 2.2 For CDI Os and the final Individual Grand Prix Freestyle Competition where four (4) Athletes have qualified for one (1) NF and only three (3) Athletes may participate, in cases of certified illness of one (1) of the qualified Athletes/Horses, the 4th Athlete will replace one (1) of the qualified Athletes from the same NF.
- 2.3 For Competitions where a maximum number of Athletes may compete upon qualification from the previous Competition at the same Event, the next best ranked Athlete will replace the withdrawn Athlete.
- 2.4 Any such withdrawal or replacement must be reported to the President of the Ground Jury by the OC. Failing to do so will entail a Warning card.

ARTICLE 425 DRAW FOR THE STARTING ORDER

1. There must be a separate draw for each Competition. The draw shall be made in the presence of the President and/or Foreign Judge of the Ground Jury, the Technical Delegate and the Chefs d'Equipe or Persons Responsible and Foreign Athlete.

Where possible, groups should have the same number of starters; and where possible, five (5) Athletes per group. If the numbers are not evenly divided by five (5), the first group shall be the smallest i.e. for twenty three (23) Athletes: Group 1= three (3) Athletes, Group 2= five (5) Athletes, Group 3= five (5) Athletes, Group 4= five (5) Athletes and Group 5= five (5) Athletes. Athletes holding the same placing on the World Dressage Ranking List shall be drawn within the same group and groups must be adapted accordingly.
2. Individual Competitions. The draw for the starting order in individual Competitions should be made regardless of nationality. Should an Athlete have more than one (1) Horse, the order of starting may have to be adjusted to ensure that a gap of at least one (1) hour is left between their Horses. If the number of participants is so small that this gap cannot be obtained, the Athlete may decide in which sequence to start their Horses. For all Competitions not specified in these rules, an ordinary draw will be conducted.
 - 2.1 CDI: For the Grand Prix Competition, the OC may choose to conduct
 - a) An ordinary draw; or,
 - b) A draw in groups of five (5) conducted in reverse order of the World Dressage Ranking List. (Not listed Athletes to be drawn first).

The type of draw used by the OC must be stated in the Schedule. If a judges exam takes place during the Competition a) an ordinary draw must be used.
 - 2.2 CDI-W: The draw for the Grand Prix shall be conducted in reverse order of the World Dressage Ranking List, in groups of five (5).
3. CDIO and FEI Championships. The draw for the order of starting in team Competitions including both team and individual Athletes will be conducted in the following manner:

- 3.1 The Chef d'Equipe of each team will determine the starting order of team members within their team. The Chef d'Equipe must deliver to the Event Director, at the latest two (2) hours before the draw of the competition, a sealed envelope containing the order of go of the Athletes within their team.
- 3.1.1 For teams of three (3) Athletes only, the first starting position shall remain vacant.
- 3.1.2 For Championships on Grand Prix level and Games on Grand Prix level, the starting order of the teams will be drawn in groups of five, based on the average of the points of the participating team athletes on the FEI Individual World Ranking list.
- 3.2 The names of the individual Athletes are placed in a receptacle (A). Numbers equivalent to all starters are placed in a second receptacle (B).

An individual Athlete's name is drawn from receptacle A and a starting place for that individual is drawn from receptacle B. A second individual's name is drawn from receptacle A and a starting place for that individual and so on for all individuals.

When the Competition is held over two (2) days the individual starters shall be drawn in the reverse order of the World Dressage Ranking list and in two (2) groups the highest placed Athletes drawn on the second day. When the Competition is held in one (1) day the starting field will be divided in two (2) groups and the highest placed Athletes on the world ranking list will be drawn last.

- 3.3 Numbers equivalent to the starting number of teams are placed in a receptacle (C) and placed in another are the names of nationalities of competing teams (D). Then a draw is made for the name of a team, which will be followed by a draw for a number, giving a team its starting order. This continues until the order of the last team is drawn. When the competition is held over two (2) days, all teams must have two (2) Athletes on the second day.
- 3.4 The starting list is made out with the individual Athletes placed in the positions they have drawn. The team Athletes are then inserted in sequence in the remaining places.
- 3.5 The draw for the individual Competitions at CDI Os and FEI Championships shall be conducted in the following manner:

Grand Prix Special: In reverse order of result from the Grand Prix, in groups of five (5).

Grand Prix Freestyle: In reverse order from result from Grand Prix Special, in groups of five (5).

The draw for the Individual Competitions at FEI-Championships for Young Riders, Juniors, Children and Pony Riders shall be an ordinary draw.

4. Grand Prix Special.

At all CDI3*/CDI4*/CDI5* Events there will be a draw in groups of five (5) for the order of starting in the Grand Prix Special. A draw first within the group of Athletes placed 11th to 15th and then within the group of Athletes placed 6th to 10th and last the group of Athletes placed 1st to 5th i.e. the five (5) best Athlete/Horse combinations will start last.

5. Freestyle Tests

At all CDI events there will be a draw in groups of five (5) for the starting order in the Freestyle. A draw first within the group of Athletes placed 11th to 15th including ties for 15th place, and then within the group of Athletes placed 6th to 10th and last the group of Athletes placed 1st to 5th i.e. the five (5) best Athlete/Horse combinations will start last.

6. Borrowed Horses. Refer to for Competitions on Borrowed Horses.

7. Regional Games. For the team test, the usual draw according to Article 425.3 of these Rules apply. For the individual Competition there will be a draw in groups of five (5). Groups of Athletes placed 11-15 to start first.
8. The starting order for all Competitions for which Athletes have had to qualify by competing in an earlier competition(s), shall be determined by way of a draw in groups of five (5). The draw must be stipulated in the Schedule. In case of ties within one (1) starting group the combinations that are tied shall be drawn in the same group and numbers adjusted accordingly.
9. If the Schedule permits the Athlete to start two (2) or more Horses in the Grand Prix, the OC has to define in the Schedule which Horse goes forward to the Grand Prix Special and to the Grand Prix Freestyle if both qualify.
10. Youth Championships

For the Team and Individual tests, an ordinary draw will determine the starting order in each Test. For the Freestyle test, there will be a draw in groups of five (5) in reverse order from the rankings of the individual competition. First drawn is a group of three (3), placed 18th to 16th. The Athletes in the group ranked 18th to 16th will start first, followed by the group ranked 15th to 11th, and so on.

ARTICLE 426 — ATHLETE WEIGHT

ARTICLE 427 DRESS

1. Protective Headgear* and top hat/bowler:

- 1.1 As a general rule, a properly fastened Protective Headgear* has to be worn by all Athletes (as well as any other person) at all times when mounted and by Children, Pony riders, Juniors, Young riders and U25 for the Horse inspection. It is recommended to be worn by any other person presenting the Horse in a Horse Inspection.
- 1.2 Any Athlete (as well as any other person) violating this provision must immediately be prohibited from further riding until the Protective Headgear is properly in place.

If an Athlete chooses to remove their Headgear at any time, whether permitted or not by these rules, such removal shall always be entirely at their own risk.

- 1.3 A Protective Headgear formed as a top hat may be used.

Note*: Protective Headgear is defined in Appendix A in the FEI GRs.

2. Civilians. The following is compulsory:

Protective Headgear*:	black or dark colour
Breeches:	white or off white
Stock or tie:	white or off white
Gloves:	white, off white or same colour as coat
Riding boots:	black or dark colour
Spurs:	see paragraph 4 below.

- 2.1 Tailcoats/jackets: any single colour tailcoat or jacket (approved by the Athlete's NF) will be allowed. Striped or multi-coloured coats or jackets are not permitted. Tasteful and discreet accents, such as a collar of a different hue or modest piping or crystal decorations, are acceptable.

2.2 At all CDIP/CDICh/CDIYH (5 and 6 yo), a jacket must be worn.

- ~~2.32-2~~ In bad weather, the Ground Jury may allow the wearing of light waterproof coat. In very warm weather, the Ground Jury may allow Athletes to ride without a jacket.
3. **Military, Police, etc.** may wear civil or service dress at all international Events. Service dress does not only apply to Members of the Armed Forces and Police, but also to members and employees/students of other State/Military Establishments and National Studs/schools/institutes. They must comply with all Protective Headgear requirements.
 4. **Spurs** are compulsory except for CDIP and CDICH Events and must be made of metal. The shank must be either curved or straight pointing directly back from the centre of the spur when on the Athlete's boot. The arms of the spur must be smooth and blunt. If rowels are used, they must be blunt/smooth (no sharp edges) and free to rotate. Metal spurs with round hard plastic knobs are allowed ("Impuls" spur). "Dummy" spurs with no shank are also allowed.
 - 4.1 In Children and Pony competitions, spurs are optional but if used, only blunt metal spurs no longer than three point five centimetres (3.5 cm) measured from the boot to the tip are allowed. Spurs with rowels are not allowed.
 5. **Earphones** and/or other electronic communication devices are strictly prohibited at FEI Dressage Competitions whilst competing, and such usage is penalised by elimination. Earphones or similar devices are however permitted during training and warm-up.

ARTICLE 428 SADDLERY

The following are compulsory:

1. **Dressage saddle**, which must be close to the Horse and have long, near-vertical flaps, and English-style or safety stirrups.
 - 1.1 Stirrups must have closed branches, and no attachments. The foot must not be fully or partially enclosed and must in no way be attached to the stirrups (for example with magnets). Safety stirrups may have an opening on the outside branch.
 - 1.2 Saddle pads are optional but should be white. Plain colour saddle pads may be used. Contrast colouring and piping is allowed. Striped or multi coloured pads are not permitted.
 - 1.3 No saddle covers are allowed.
2. **Bridle with noseband.**
 - 2.1 Except for the buckles and padding the headstall and noseband must be made entirely of leather or leather-like material. Padding is allowed on bridles. Nylon or other non-metal material may be used to reinforce leather in the headstall but must not be in direct contact with the horse. Elastic inserts are permitted in the crownpiece and cheek pieces only and must not be in direct contact with the horse or the bit.
 - 2.1.1 A browband is required, and except for the parts that attach to the crownpiece or headstall, is not required to be made of leather or leather-like material.
 - 2.1.2 The crownpiece of the bridle must lie immediately behind the poll and may extend forward onto the poll but must not be fitted to lie behind the skull.
 - 2.1.3 A throatlatch is required except when the combined noseband or Micklem bridle are used.
 - 2.1.4 A rein is a continuous, uninterrupted strap or line from the bridle bit to the hand. Rein additions or attachments are not permitted. Each bit must be attached to a separate rein and reins may only be attached to the bit. Reins must not be made of rope or rope-like material.

- 2.1.5 At any level of competition, a noseband may never be so tightly fixed that it causes harm to the horse and must be checked as per the Stewards Manual noseband protocol.
- 2.2 For CDI/CDIO3*/4*/5*/U25, CDI-Ws and Championships/Games (except Ponies, Children, Juniors and Young Riders), a double bridle with cavesson noseband is mandatory i.e. bridoon and curb with curb chain. A combined noseband may be used without the lower “flash” strap. The curb chain can be made of metal, leather or a combination. Lip strap and rubber, leather or sheepskin cover for curb chain are optional. Neither a cavesson noseband nor a curb chain may ever be as tightly fixed so as to harm the Horse.
- 2.2.1 A snaffle bridle or double bridle is allowed in CDI1* and 2*, CDIO2*, CDIJ, CDIOJ, CDIY, CDIOY, CDIAm and CDIYH for seven (7) year old Horses and Junior and Young Rider Championships.
- 2.2.2 For CDIP/Ch, CDIOP/Ch, Ponies and Children Championships, CDIYH for five (5) and six (6) year old Horses, and as marked on test sheets, a snaffle bridle is to be used.
- 2.2.3 A plain snaffle bridle is required to be used with a regular cavesson noseband, a dropped noseband, a flash noseband, a crossed noseband, a combined noseband or a Micklem or similar design of bridle.
3. **Bits.** Snaffle, Bridoon and curb bits must have a smooth surface. Twisted and wire bits are prohibited. Bits must be made of metal, rigid plastic, or durable synthetic material and may be covered with rubber/latex. Bits must not place mechanical restraint upon the tongue. The diameter of the mouthpiece of the bridoon/snaffle and/or curb must be such so as not to hurt the Horse. Minimum diameter of mouthpiece to be twelve millimetres (12 mm) for curb bit, and ten millimetres (10 mm) for bridoon bit. Snaffles must have a minimum diameter of twelve millimetres (12 mm) for horses and ten millimetres (10mm) for Ponies. The diameter of the mouthpiece is measured adjacent to the rings or the cheeks of the mouthpiece.
- 3.1 Snaffle Bits – snaffle bits are permitted when the use of a double bridle is not required.
- 3.1.1 Snaffle bits may be used with loose ring, D-Ring, Eggbutt and hanging cheeks. Single or double jointed snaffles may also be used with upper or lower cheeks, full cheeks or Fulmer cheeks. Loose rings may have a sleeve fitted around part of the ring.
- 3.1.2 Flexible rubber or synthetic mouthpieces are permitted.
- 3.1.3 A snaffle may have up to two joints. A barrel or ball joint is permitted as the centre link in a double jointed snaffle, however, the surface of the centre piece must be solid with no moveable parts other than a roller. The centre link may be tilted in a different orientation from the mouthpiece but must have rounded edges and may not have the effect of a tongue plate.
- 3.1.4 A double jointed snaffle or snaffle with rotating mouthpiece may be shaped to allow tongue relief. The maximum height of the deviation is 30mm from the lower part of tongue side to the highest part of the deviation. The widest part of the deviation must be where the mouthpiece contacts the tongue and must have a minimum width of 30mm. The mouthpiece of a jointed or unjointed snaffle may be shaped in a curve within the dimensions specified above.
- 3.2 Bridoon bits – a bridoon bit is defined as a snaffle bit that is used together with a curb bit to form a double bridle.
- 3.2.1 Bridoons may be used with loose ring and eggbutt cheeks.
- 3.2.2 Bridoons must have one or two joints. A barrel or ball joint is permitted as the centre link in a double jointed bridoon, however, the surface of the centre piece must be solid with no moveable parts other than a roller. The centre link may not have the effect of a tongue plate.
- 3.2.3 Bridoons where the centre link(s) of the bit can lock and have the effect of a mullen mouth snaffle are not permitted.

3.2.4 Flexible rubber/synthetic bridoons are not permitted.

3.3 Curb Bits

3.3.1 The length of the lever arm below the mouth piece of the curb bit is limited to ten centimetres (10 cm). The upper cheek must not be longer than the lower cheek and must not exceed five centimetres (5 cm). If the curb has a sliding mouthpiece, the lever arm of the curb bit below the mouth piece should not measure more than ten centimetres (10 cm) when the mouth piece is at the uppermost position.

3.3.2 Curbs may have straight or S-shaped cheeks. They may have rotating lever arms.

3.3.3 The mouthpiece may be straight or shaped to allow tongue relief. The maximum height of the deviation is 30mm from the lower part of tongue side to the highest part of the deviation. The widest part of the deviation must be where the mouthpiece contacts the tongue and must have a minimum width of 30mm.

3.3.4 Curb chain can be made of metal or leather or a combination. Cover for curb chain can be made of leather, rubber or sheep skin. Curb chain hooks can be fixed or not fixed.

4. **Whips.** At all international Events, it is forbidden to carry a whip of any kind while competing in the arena. However, the use of one (1) whip, with a total maximum length of one meter and twenty (1.20 m) (pony Competitions maximum one meter -1 m-), in the practice area is allowed. The whip must be dropped before entering the space around the Competition arena or the Athlete will be penalized. See Article 430 of the Dressage Rules.

Upon arrival on the showground, only the Athlete when riding, walking in hand, leading or lunging a Horse (lunge whip allowed), is allowed to carry a whip (maximum one meter and twenty -1.20 m-/ponies maximum one --1 m-) anywhere on the showground. The groom may also walk, lead and lunge a Horse as above. Other parties are allowed to carry a whip, provided it is not in connection with the training of the Horse. For safety reasons, whips at prize-giving ceremonies are allowed.

5. **Gadgets.** Martingales, breast plates, bit guards, ~~boots~~, any kind of gadgets (such as bearing, side, running or balancing reins, nasal strips etc.) and any form of blinkers that interfere with the Horse's vision are, under penalty of elimination, strictly forbidden during training, warm-up and competitions. See Article 430 of the Dressage Rules.

6. Additional Items:

6.1 **False tails/tail extensions** are permitted only with the prior permission of the FEI. Requests for such permission should be directed to the FEI Dressage department accompanied by photographs and a veterinary certificate. False tails may not contain any metal parts, (except for hooks and eyelets), or extra added weight.

6.2 **Ear hoods** are permitted for all Events and may also provide noise reduction. However, ear hoods must not cover the horse's eyes and ear plugs are not permitted, with the exception of Article 428.6.3. The ear hoods should be discreet in colour and design. Ear hoods may not be attached to the noseband.

6.3 **Earplugs** on Horses are allowed at Horse Inspections and prize-giving ceremonies only.

6.4 Any decoration of the Horse is not allowed. It is not allowed to paint any part of the horse's body. Using coloured wound-spray and ointment if necessary is permitted, but it cannot be used to obscure an existing wound or injury.

6.5 it is strictly forbidden to use any type of white substance (like "marshmallow fluff", shaving cream etc.) around the horse's mouth to imitate foaming; this is considered cheating and against horse welfare as it can hide lip injuries. This will result in a warning or a yellow card.

7. Fly masks: ~~Blinkers and~~ fly masks ~~that cover the Horse's eyes~~ are forbidden in the training and competition arena.
8. **Checking of Saddlery.** A visual check before leaving the last warm up arena may be conducted by the Stewards to prevent Athletes going into the field of play with any forbidden equipment. A visual check can be declined, as it is designed to help Athletes but is not compulsory. However, it remains the full responsibility of the Athlete not to enter with any forbidden piece of Saddlery. A Steward must be appointed to check the Saddlery of each Horse immediately after it leaves the arena. Any discrepancy will be reported to the Judge at C and result in immediate Elimination if confirmed. The checking of the bridle must be done with the greatest caution, as some Horses are very sensitive about their mouths (see FEI Steward's Manual). It shall be the Athlete's/groom's responsibility to remove ear hoods. The Steward must use disposable surgical/protective gloves when checking the bridle (one -1- pair of gloves per Horse).
9. **Warming-up and training areas.** Paragraphs 1 to 5 above are valid also for warming-up arenas and other training areas where, however, snaffles with a cavesson or a normal dropped noseband, Mexican noseband or a Flash noseband, boots, bandages are allowed.

Lunging cavessons, single direct side reins or double sliding side reins (triangle/dreieck zügel) are permitted when lunging. Lunging is allowed with one (1) lunge line only, attached to either a lunging cavesson or a snaffle bridle/bridoon. Lunging with lunge line attached to the curb is not allowed.
10. **Identification number.** Each Horse keeps the same identification number provided by the Athlete throughout the Event. It is compulsory that this number is worn by the Horse while actively competing and at any time while working in the exercise and schooling areas or being hand walked (from the time of their arrival until the end of the Event) so that they can be identified by all Officials including the Stewards. Failure to display this number incurs firstly a warning and, in the case of a repeated offence, a fine imposed on the Athlete by the Ground Jury. The identification numbers shall be discreet on white background, the colour of the numbers may vary.
11. **Boots and bandages:** At all international Events, boots and/or bandages on the Horse's legs are forbidden while competing in the arena. The boots and/or bandages must be removed before entering the space around the Competition arena or the Athlete will be penalized. See Article 430 of the Dressage Rules.

ARTICLE 429 ARENA AND EXERCISE AREAS (FOR DIAGRAM SEE ANNEX ARENA)

- 1.1. **Approval.** At Olympic Games, Regional Games, and FEI Championships the Competition arena has to be checked and approved by the Technical Delegate. The appointed Foreign Athlete will be consulted during that process.
- 1.2. At all other International Events, the Competition arena has to be checked and approved by the Foreign Judge or the President of the Ground Jury. The appointed Foreign Athlete will be consulted during that process.

The Foreign Athlete is defined as the OC designated Athlete at International Events

2. **Arena Specifications.** The arena, flat and level, must be sixty meters (60 m) long and twenty meters (20 m) wide. The difference in elevation across the diagonal or along the length of the arena shall in no case exceed sixty centimetres (60 cm). The difference in elevation along the short side of the arena shall in no case be more than twenty centimetres (20 cm). The arena must be predominantly of sand. The measurements above are for the interior of the enclosure, which must be separated from the public by a distance of not less than ten meters (10 m). Exception from this can be granted by the FEI. If the Competition is held indoors, the arena should, in principle, be a minimum distance of two meters (2 m) from the wall. The enclosure

itself must consist of a low white fence (rails which must not be solid), about thirty centimetres (30 cm) high. The part of the fence at A should be easy to remove, to let the Athletes in and out of the arena and must be kept closed during each Athlete's performance and between tests, until the Judge at C gives the starting signal. The width of the entrance must be at least two metres (2 m). The rails of the fence should be such as to prevent the Horse's hoofs from being caught. The rails may not contain any metal components. Refer to Annex 11 and 12 for details on arena.

3. **Publicity on Dressage Fence and Judges' Huts/Tables.** The FEI owns the sole right to publicity on the Dressage arena fence for all FEI Championships and FEI named Series. For these Events, the OCs may acquire publicity space from the FEI only by previous agreement, except for on the Dressage letters and their holders, where publicity is never allowed. Publicity may only be on the inside of the fence, in black only and must, with the exception of A, leave at least one meter fifty (1.50 m) free of publicity on either side of the arena letters. The short side at M C H must be completely free of publicity. There must be at least three meters (3 m) free of advertising on either side of B and E. A maximum of forty four meters (44 m) of publicity on the rails is accordingly permitted. The publicity must be positioned in a regular manner and each long side should reflect the other exactly.

The height of the sponsor brand/logo must not exceed twenty centimetres (20 cm) and the publicity must be fixed level with the top of the Dressage arena fence. Publicity may only be placed on the inside of the arena fence and never on the outside and any requirements in terms of agreements between the FEI and broadcasters as may be in force, must be respected.

Any publicity applied on the fence or Judges' huts/tables must previously be approved also by the Foreign Judge or Foreign Technical Delegate before the start of the Competition. Any publicity at the front of the Judges' huts may have a maximum dimension of 2m².

In accordance with the above stated positioning of publicity, it is always permissible to place the name and/or logo of the FEI approved Event on the Dressage fence.

For example: CDIO Aachen/CDI5* Cannes/CDI-W London.

OCs who violate these rules on will be fined by the FEI as appropriate under these Rules and the FEI GRs and/or may lose the CDI status of their Event.

4. **Letters.** The letters outside the enclosure should be placed about fifty centimetres (50 cm) from the fence and clearly marked. It is compulsory to place a marker on the fence itself, level with and in addition to the letter concerned. Publicity is not allowed on letters or on letter holders. Letters should also be visible for the public.
5. **Placing of Judges.** Three (3) Judges must be placed along the short side, on the outside of and a maximum of five meters (5 m), minimum of three meters (3 m) from the arena at outdoor Competitions and preferably a minimum of two meters (2 m) at indoor Competitions; the Judge at C on the prolongation of the centre line, the two (2) others (M and H) two meters fifty (2.50 m) from and on the inside of the prolongation of the long sides. The two (2) Side-Judges (B and E) must be placed on the outside of and a maximum of five meters (5 m), minimum three meters (3 m) from the arena at B and E respectively; at indoor Competitions preferably a minimum of two meters (2 m). When three (3) Judges are used one (1) should sit on the long side. See Article 437 of the Dressage Rules. When seven (7) Judges are used, the two (2) additional Judges will sit at the opposite short side of the Judge at C, five meters (5 m) from and on the inside of the prolongation of the long sides. Exceptions from this may only be approved by the FEI.
6. **Judges' hut.** A separate hut or platform must be provided for each Judge. It must be raised not less than fifty centimetres (50 cm) (for Freestyle Tests possibly a little higher) above the ground, in order to give the Judges a good view of the arena. The booth/hut must be large enough to accommodate four (4) persons. Judges' huts should provide good views of the entire arena. For FEI Championships and Games on Grand Prix level, each Judges hut must be

equipped with a button linked to the Judges Signalling System, allowing each judge to discreetly inform the C-Judge in case of blood, lameness, error of course or equipment. A Judges Signalling button is optional for other Events.

6.1 Only officiating people (to include Officials fulfilling promotion requirements) are allowed in the Judges' huts. Any exceptions must have the prior approval of the PGJ and must be included in the Foreign Judge report to the FEI. No media nor recording equipment are allowed in the Judges' hut.

7. **Pause.** It is necessary to pause for about ten (10) minutes after every six (6) to ten (10) Athletes, to reconstitute the surface of the ground.
A pause or break during a Dressage Competition may never exceed more than two (2) hours (lunch, etc.) and must not be interrupted by another Competition. (special permission may be granted by the FEI). An exception to this rule may only be granted under extraordinary circumstances by FEI HQ (request to be submitted in writing to the FEI). If a small in-between class is scheduled, it should be judged by another panel of Judges.

However, if the number of Athletes in a Competition exceeds approximately forty (40) the OC must spread this Competition over two (2) days.

8. **Entering the arena.** For Competitions where it is not practical for the Athletes to ride their Horses around the outside of the arena prior to entering the arena, Athletes are permitted to enter the arena before the bell is sounded. After the bell has sounded, the Athlete starts the test from within the arena.

For Competitions where it is possible to ride a Horse around the outside of the arena, the Athlete is allowed to enter the space around the arena before the bell is sounded but may only enter the arena after the bell has been sounded.

The Judge at C is responsible for bell and clock/time.

9. **Training in arena.** On no account and under penalty of disqualification, may an Athlete/Horse use the Competition arena at any time other than during their performance in a Competition or when at the discretion of the OC the main arena is open for training (see below). Any exceptions must be approved by the Technical Delegate or the President of the Ground Jury.
10. **Practice Arena.** At least one (1) practice arena of sixty meters (60 m) by twenty meters (20 m) must be placed at the disposal of the Athletes preferably a minimum of two (2) days before the first Competition of the Event. If possible, this arena should be of the same consistency as the Competition arena footing.

Where it is not practically feasible to provide a practice arena of sixty (60) metres by twenty (20) metres, the Athletes must be permitted to exercise their Horses in the Competition arena. A fixed time Schedule setting out the times during which the Competition arena may be used for training purposes should be clearly set out in the Schedule. If training is permitted in the Competition arena, it is recommended that the set-up of the final warm-up in the Competition arena is as similar as possible to the final Competition set-up.

The "ten (10) minutes Arena" is the last practice arena before entering the Competition arena. A ten (10) minutes Arena is obligatory for Olympic Games and FEI Championships and recommended for all other CDIs/CDIOs.

- 10.1 The ten (10) minutes arena must have the same footing as the main arena.
- 10.2 The Athlete may enter the ten (10) minute arena following the departure of the Athlete who enters the main arena. There may never be more than one (1) Athlete in the ten (10) minutes arena, unless otherwise decided by TD/FJ.
- 10.3 It is not obligatory for an Athlete to use the ten (10) minutes arena.

- 10.4 A steward must be present at all times to supervise all training/warm-up from the official opening time of the stables and may enforce rules prior to the official start of the Event.
- 10.5 Adjusting of saddlery is allowed and normal caring for the Horse is allowed.
11. **Interruption.** In case of any technical failure that will interfere with the Competition, the Judge at C shall ring the bell. It is recommended that in clear cases of external disturbance, the same procedure is applied. During extreme weather conditions or other extreme situations the Judge at C may ring the bell for interruption of the test. The Technical Delegate/OC may also suggest to the Judge at C to stop the Competition. The affected Athlete should return to complete their test when conditions so permit.

In the case of an Athlete's music failing during a Freestyle Test and in cases where there is no back-up system, the Athlete can, with the permission of the Judge at C, leave the arena. There should be minimum interference with the starting times of the other Athletes. The affected Athlete should return to complete or restart their test during a scheduled break in the Competition or at the end of the Competition. The Judge at C, after conferring with the Athlete, will determine when the Athlete should return to the arena. It is up to the Athlete whether to restart the test from the beginning or to commence from the point where the music failed. In either case, the marks already given will not be changed.

If there are foreign objects in the arena which could have an influence on performance, the test has to be stopped and the Athlete can continue once the object has been removed.

If an Athlete has to restart an ordinary test, they can choose to start from the beginning of the test or from where stopped. Any scores given before the interruption remain.

ARTICLE 430 EXECUTION OF THE TESTS

The Official FEI tests must be carried out entirely from memory, and all movements must follow in the order set forth in the test.

1. **Sound of bell.** After the sound of the bell, the Athlete must enter the arena at A within forty five (45) seconds. In the Freestyle, the Athlete has forty five (45) seconds to signal to start the music and must enter the arena within thirty (30) seconds of the music starting.

During Freestyle tests, in case of technical failure or delay in start of the music, the Judge at C can interrupt the count and re-continue after the problem has been resolved. The Judge at C is responsible for the bell and clock/time. A clock showing forty five (45) seconds, should be used whenever possible, and should always be clearly visible for the Athlete.

In the event that the Horse starts to defecate or urinate, the clock will be stopped until the Horse is ready to continue at which point the clock will be restarted.

2. **Salute.** Athletes must take the reins in one (1) hand at the salute. Athletes with top hat/bowler have the choice to take the hat off or just nod.
3. **Error of course.** When an Athlete makes an "error of course" (takes the wrong turn, omits a movement, etc.) the Judge at C warns them, by sounding the bell. The Judge at C shows the Athlete, if necessary, the point at which they must take up the test again and the next movement to be executed, then leaves them to continue on their own. However, in some cases when, although the Athlete makes an "error of course", the sounding of the bell would unnecessarily impede the fluency of the performance - for instance if the Athlete makes a transition from medium trot to collected walk at V instead of at K, or, cantering up the centre line from A, makes a pirouette at D instead of at L - it is up to the Judge at C to decide whether to sound the bell or not. However, if the bell is not sounded at an error of course and the test requires the same movement to be repeated and the Athlete again makes the same error, the Athlete is only penalised once.

The decision as to whether or not an error of course has been made will be at the sole discretion of the Judge at C. The other Judges' scores will be adapted accordingly.

4. **Error of test/execution.** When an Athlete makes an "error of the execution of the test" (trots rising instead of sitting, etc.) they must be penalised as for an "error of course". In principle an Athlete is not allowed to repeat a movement of the test unless the Judge at C decides on an error of course (sounds the bell). If, however, the Athlete has started the execution of a movement and attempts to do the same movement again, the Judges must consider the first movement shown only and at the same time, penalise for an error of course.
5. **Unnoticed error.** If the Ground Jury has not noted an error, the Athlete has the benefit of the doubt and will therefore not be penalised for the error.

6. Penalties

6.1 "Error of Course".

Every "error of course", whether the bell is sounded or not, must be penalised, except as noted above.

First error	Two (2) percentage points from the total score (per Judge).
Second error	Elimination.

For Young Horses tests, Children, Pony Riders and Junior tests, the deduction for the first error is zero point five percentage points (0.5%) from the total score, for the second error one percentage point (1%) and for the third error, Elimination

6.2 Other Penalties – Technical faults

It is the responsibility of the Judge at C to decide whether a penalty should be applied and the other judges sheets should be marked accordingly to ensure consistency.

All of the following are considered technical faults, and ~~two (2) points~~ 0.5% (zero point five percentage points) will be deducted per fault by each Judge, but ~~they these deductions~~ are not cumulative and will not result in Elimination (including for Freestyle tests):

- Entering the space around the arena with a whip or with boots/bandages on the Horse's legs or with discrepancy in dress (e.g. lack of gloves) and/or
- Entering the Dressage arena with a whip or with boots/bandages on the Horse's legs or with discrepancy in dress (e.g. lack of gloves). If the test has already started before the discrepancy has been noticed, the Judge at C stops the Athlete and if needed and possible, an assistant may enter the arena to remove the item(s). The Athlete then continues the test, either starting from the beginning (from the inside of the fence) or from the movement where they were stopped. The marks given before they were stopped are not changed;
- Entering the arena before the sound of the bell;
- Not entering the arena within forty five (45) seconds after the bell, but within ninety (90) seconds;
- For Freestyle tests, entering the arena after more than thirty (30) seconds of music;
- Using voice or clicking the tongue repeatedly
- Athletes not taking the reins in one (1) hand at the salute.

If the Freestyle test is longer or shorter than stipulated on the test sheet, zero point five percentage points (0.5%) will be deducted from the total artistic score, for other technical faults 0.5% (zero point five percentage points) will be deducted per fault from the technical score.

- 6.3 **Penalty Percentage Points.** The penalty percentage points are deducted on each Judge's sheet from the total points obtained by the Athlete. In Children classes and classes for 7 yo Horses, penalty percentage points have to be deducted from both judging procedures (technical judges and quality judges).

7. **Elimination.**

7.1 **Lameness.** In a case of marked lameness, the Judge at C informs the Athlete that they are eliminated. There is no appeal against this decision.

7.2 **Resistance.** Any resistance which prevents the continuation of the test longer than twenty (20) seconds is punished by Elimination. However, resistance that may endanger Athlete, Horse, Officials or the public will ~~be~~ result in elimination for safety reasons earlier than within twenty (20) seconds. This also applies to any resistance before ~~the~~ entering the Dressage arena ~~or when leaving the arena.~~

7.3 **Fall.** In the case of a fall of a Horse and/or an Athlete, the Athlete will incur in Elimination.

7.4 **Leaving Arena During Dressage Test.** A Horse leaving the arena completely, with all four (4) feet, during a Dressage Competition between beginning and end of the test will be eliminated.

7.5 **Unauthorised Assistance.** Any outside help by voice, signs, etc. (earphone and/or electronic communication devices included) is considered as illegal or unauthorized assistance to an Athlete or to their Horse. An Athlete or Horse receiving unauthorised assistance must be eliminated.

7.6 **Bleeding:**

7.6.1 If the Judge at C suspects fresh blood anywhere on the Horse during the test, they will stop the Horse to check for blood. If the Horse shows fresh blood, it will be eliminated. The elimination is final. If the Judge through examination clarifies that the Horse has no fresh blood, the Horse may resume and finish its test.

7.6.2.1 If the FEI Steward discovers fresh blood in the Horse's mouth or in the area of the spurs during the check at the end of the test (Article 430.9), they inform the Judge at C, who will eliminate the Horse and the Athlete.

7.6.2.2 If the FEI Steward discovers fresh blood anywhere else on the Horse's body (i.e. other than the Horse's mouth or in the area of the spurs) during the check at the end of the test, the Athlete/Horse combination is not automatically eliminated. The FEI Chief Steward shall inform the Judge at C whether the Horse is fit to continue in following competition(s) in the Event. The Judge at C will take a decision on the Horse's fitness to continue, based on the FEI Veterinarian's advice. If the Judge at C decides the Horse is not fit to continue, the Horse will not be permitted to take part in any further Competition(s) or tests at the Event, but the result(s) obtained by the Athlete/Horse combination in any Competition(s) or tests already completed shall stand.

7.6.3 If the Horse is eliminated pursuant to the above, or if the Horse is injured during the test and starts bleeding after finishing the test, it should be examined by an FEI Veterinarian prior to the next Competition to determine if it is fit to continue in the Event the following day(s). The decision of the FEI Veterinarian is not subject to appeal.

7.7 **Other Reasons for Elimination**

- Horse and Athlete combination not being able to fulfil the requirements of the level.
- The performance is against the welfare of the Horse and/or shows abusive riding.
- Horse and Athlete combination not entering the Competition arena within ninety (90) seconds after the bell. Except where a valid reason thereto has been informed to the Judge at C (valid reason may be losing a shoe, etc.).
- Riding with non-permitted equipment which is not covered under Article 430.6.2.

8. **Execution of Movement at Certain Point.** In a movement which must be carried out at a certain point of the arena, it should be done at the moment when the Athlete's body is above this point, except in transitions where the Horse approaches the letter from a diagonal or

perpendicular to the point where the letters are positioned. In this case, the transitions must be done when the Horse’s nose reaches the track at the letter so that the Horse is straight in the transition. This includes the execution of flying changes.

9. **Beginning/End of Test.** A test begins with the entry at A and ends after the salute at the end of the test, as soon as the Horse moves forward. For the sole purpose of checking the Athlete/Horse for blood or correct equipment, the test is not considered ended until after the check of the equipment. Any incidents before the beginning or after the end of the test have no effect on the marks. The Athlete should leave the arena in the way that is prescribed in the text of the test.
10. **Details to The Freestyle Test.** An Athlete must enter the arena within thirty (30) seconds of the music starting.

At the beginning and end of a Freestyle Test a halt for the salute is compulsory. The test time will start after the Athlete moves forward after the halt and stop with the final salute.

Refer further to Dressage Judging Guidelines published on the FEI Website.

11. **Details for competitions for Young Horses**

Refer further to the FEI Dressage Handbook.

ARTICLE 431 TIME

Time of tests. Only Freestyle tests are timed (Article 421 of the Dressage Rules). The time shown on the other Judge’s sheet is for information only.

ARTICLE 432 MARKING

1. All movements, and certain transitions from one to another, which have to be marked by the Judges, are numbered on the Judge’s sheet.
2. They are marked from zero (0) to ten (10) by each Judge, zero (0) being the lowest and ten (10) the highest mark.
3. The scale of marks is as follows:

10	Excellent	7	Fairly good	4	Insufficient	1	Very bad
9	Very good	6	Satisfactory	3	Fairly bad	0	Not executed
8	Good	5	Sufficient	2	Bad		

All Half marks from 0.5-9.5 may also be used both for movements and the collective mark, at the discretion of the judge.

“Not executed” means that practically nothing of the required movement has been performed.

In Freestyle Tests, half marks may be used for all marks and 0.1 decimals may be used for the artistic marks.

In tests for Young Horses, decimals to .1 may be used

Collective mark: After the Athlete has finished their performance, a collective mark is awarded for General impression. [This change is to come into force as of 01.01.2021 with a clear definition]

The Collective mark is awarded from zero (0) to ten (10).

The collective mark, as well as certain difficult movements, can be given a coefficient, which is fixed by the FEI.

ARTICLE 433 JUDGES' SHEETS

1. General

- 1.1 The Judges' sheets have two (2) columns: the first for the Judge's original mark, the second for the corrected score. Any corrected score must be initialled by the Judge having made the correction. Judges' scores must be endorsed by the Judge.
- 1.2 There is also a column for the Judge's remarks, where the Judge as far as possible, should state the reason for the judgment. Remarks must be in English. Giving remarks is strongly recommended, when giving marks of five (5) and below. Remarks are intended for the information of the Athlete.
- 1.3 The original of the Judges' sheets of the placed Athlete/Horse combinations from the Olympic Games must be sent to the FEI by the OC, together with the results of each Competition, including a list where the total percentage awarded by each Judge for each Athlete must be clearly shown. A copy of the Judges' sheets should be available to the Athletes.
- 1.4 The final results of the class must be signed off by the President of the Ground Jury or the Foreign Judge/TD as appropriate.
- 1.5 All FEI Dressage test sheets can be downloaded from the FEI website.
- 1.6 When there is a JSP, signed form with the JSP correction will be added to the normal Judges' sheets and made available to the Athletes. A copy of the form will be given to the respective Judge, whose mark was corrected.

2. Paper Judging

- 2.1 The original Judges' sheets from CDIs and CDIOs should be available to the Athletes after the Competition. No copies are required by the FEI.

3. Paperless Judging

- 3.1 The use of a paperless judging system is subject to FEI Approval and must be stated in the Event schedule.
- 3.2 Only FEI approved paperless judging systems as per the FEI requirements posted on the FEI Website may be used.
- 3.3 In any event, a paper version of the Dressage tests must be available to the Judges during competition as backup.
- 3.4 The electronic judges' sheets will be made available to the Athletes in an electronic format via the FEI platform after the competition. The access to the Athletes' electronic judges' sheets is strictly personal.

ARTICLE 434 CLASSIFICATION

1. After each performance and after each Judge has given their collective mark and signed the sheets, these pass into the hands of the scorers. The marks are multiplied by the corresponding coefficients, where applicable, and then totalled.
2. The total score for the classification is obtained by adding the total points on each of the Judges' sheets, eventually corrected for changes by the JSP, and converted to percentage. Penalty

percentage points for errors of course are deducted from the total score (per Judge). All results and scores (to include artistic and technical % scores) must be published in percentages with numbers to three (3) places after the decimal point.

3. The individual Classification (CDIs) is decided as follows:
 - 3.1. In all Competitions the winner is the Athlete having obtained the highest total percentage, the second placed Athlete is the one with the next highest total and so on.

Ties. In case of equality of percentage for the first three (3) places, the highest total median score of the Judges will decide the placing. The median score is the middle number. To calculate the median of a set of scores, the scores need to be put in ascending numerical order. E.g. 68.5% - 69% - **70%** - 70.5% - 71%; 70% is the median score in this case.

In case of equality of percentage in a Freestyle Test for the first three (3) places, the higher artistic marks will decide on the better placing.

In case of equality of percentage for remaining places, the Athletes are given the same placing.

- 3.2 Ties in Young Horses Competitions.

In case of equality of percentage for the first three (3) places, the following system must be used to break the tie: add the marks for "submission" and "perspective", and divide by two; the Athlete/Horse combination with the higher average mark will be ranked highest. If still tied, the "submission" mark will decide. If still tied, the combinations will be equally placed. For the individual classification at CDIOs, FEI Championships and Olympic Games, refer to Articles 452 and 459 of the Dressage Rules.
4. The Team Classification (CDIOs) is decided as follows: in all team Competitions the winning team is the one having the highest total points of their three (3) best Athletes, the second placed team is the one with the next highest total and so on.

Ties. In case of equality of points, the higher ranked team will be the one whose lowest classified Athlete out of the three (3) has the best result.

5. Complaints/protests. In the case of a protest/complaint being made about formal mistakes only the accredited official video (if official video recordings are contracted), can be used as evidence.

ARTICLE 435 CALCULATION AND PUBLISHING OF RESULTS

1. After each performance the percentage awarded by each Judge will be calculated and published separately and provisionally, in addition to the general total.
 - 1.1 The reference maximum total points to be used for the calculation is indicated on each test sheet.

For example: Grand Prix: 460 points.
 Grand Prix Freestyle: 200 points for technical and 200 points for artistic
 YH 7 y.o Final: 350 points for technical and 50 points for quality

- 1.2 Percentages: all percentage calculations must be rounded up or down to three (3) decimals after the decimal point as per the following principle and example: 0.0011-0.0014 down; 0.0015 – 0.0019 up.
2. Calculations:
 - 2.1 In tests with technical marks only, the total average percentage per Judge is calculated by adding the total marks per movement divided by the maximum total points (see 435.1.1) x 100.

- 2.2 In tests with technical and artistic marks or technical and quality marks, the total average percentage per Judge is calculated by adding the technical and artistic percentages or technical and quality percentages and dividing by two.
- 2.3 The final percentage is obtained by adding the total average percentage per Judge divided by the number of Judges.

For example: 1) Total average percentage per Judge: E= 69.990%, H=70.333%,
C=70.205% M=71.120%, B= 69.660%
 2) Final percentage: 70.262%.

3. All results published in percentages must have numbers to three (3) decimals after the decimal point.
4. At FEI Continental Championships for Seniors, Regional Games, FEI World Championships, FEI World Cup™ Dressage Finals and Olympic Games, the score given by each Judge for each movement performed by the participants must be made available in spreadsheet form (one - 1- form for each Athlete) for the use of Judges, Athletes, Chefs d'Equipe and the media.
5. If an Athlete withdraws prior to a Competition, is excused, eliminated or a "no show" prior to or during the performance of a test, the words "withdrawn" or "excused", "eliminated" or "no show" or abbreviations must appear after the Athlete's name in the result sheet.
 - Withdrawn and excused: the Athlete has cancelled their start prior to a test with a valid reason accepted by the President of the Ground Jury;
 - Retired: started but abandoned;
 - Eliminated: the Athlete has started, but the Athlete had to end the performance due to the breach of the Dressage Rules;
 - No show: the Athlete did not come to start without further information.
6. Scoring. No scoring should be visible to the judges during a test. Solutions to show a running score (total average percentage) and open scoring (average marks per movement for all judges) to the audience are encouraged.

ARTICLE 436 PRIZE-GIVING

1. Participation in the prize-giving ceremony of placed Athlete/Horse combinations is compulsory. Failure to do so entails losing the classification (rosette, plaque, prize in kind, prize money). Exception to this rule can only be granted by the President of the Ground Jury/Foreign Technical Delegate and/or the Judge at C for the particular Competition. Dress and saddlery have to be the same as in the Competition, however black or white bandages earplugs on horses and carrying a whip are allowed. For safety reasons Athletes are not allowed to carry flags or other items during prize giving. Only winner rugs/blankets are allowed to be worn by Horses during prize-giving.
2. Rosettes should be placed on the Horses' bridles prior to prize-giving.
3. The President of the Ground Jury or Judge at C in the Competition may be involved in the prize-giving ceremony and shall approve any exceptions to the above procedure if necessary.
4. See also recommendations for prize-giving ceremonies (FEI website). Very loud music which may excite and frighten Horses is not allowed and at all times when Horses are grouped together - prize-giving, Horse inspections, etc. - Athletes and/or grooms and everyone involved must act in a responsible way.

5. Carelessness or irresponsible behaviour may result in the giving of a Yellow Warning Card. Acts of gross irresponsibility or carelessness resulting in accident will be reported to the FEI for further action. Refer to FEI GRs.
6. It is allowed, for safety reasons, to carry a whip in the prize-giving ceremony.

CHAPTER III GROUND JURY, JUDGES' SUPERVISORY PANEL, VETERINARY COMMISSION AND VETERINARY DELEGATE, STEWARDS AND ABUSE OF HORSES

ARTICLE 437 GROUND JURY

1. At all international Dressage Competitions, the Ground Jury must consist of a minimum of three (3) and a maximum of seven (7) members as described in Annex 7. Members of the Ground Jury shall be International Judges from the FEI list. Judges are defined in four (4) categories: 2* (new), 3* (formerly International Candidate), 4* (formerly International) and 5* (formerly Official international) Judges.
2. At Olympic Games and FEI Dressage Championships for Seniors at Grand Prix level and the FEI World Cup™ Dressage Final, the FEI will appoint a Ground Jury consisting of seven (7) members and one (1) reserve.

At Olympic Games, all FEI Championships, FEI World Cup™ Dressage Finals and Regional Games, all Judges must be of different nationalities.
3. All Judges of a Ground Jury must speak English.
4. Each Judge must be assisted by a secretary who speaks and writes ~~the same official language as the Judge (mandatory English and if possible, understand French.~~
5. The Judge at C may decide if they wish to be assisted, in addition to the secretary, by a special assistant, whose task is to follow the progress of the test, to inform the Judge at C of any "error of course" and/or "error of test".
6. Internal regulations for Judges are described in the Code of conduct and Codex for Dressage Judges. (see GRs)
7. **Reserve Judge.** One (1) reserve Judge must be appointed for all levels of FEI Championships and Games when seven (7) or five (5) members of the Ground Jury are appointed, in case one (1) of the Judges is unable to attend. The reserve Judge should be present for World and Continental Championships on Grand Prix level and FEI World Cup™ Dressage Finals, and whenever possible for lower level Championships and Games.
8. **FEI appointed Foreign Judge.** The Foreign Judge is appointed by the FEI and acts on behalf of the FEI. No Foreign Judge will be appointed for Events where a Foreign Technical Delegate has been appointed by the FEI.
 - 8.1 The President or a member of a Ground Jury can act as the Foreign Judge if they are of another nationality than from where the international Event is taking place. The role of the Foreign Judge is to work on behalf of the FEI to ensure a Competition is carried out according to the FEI rules and complies with the approved FEI Schedule.
 - 8.2 At FEI Regional Championships and Regional Games, CDIOs and all CDIs the President or a member of the Ground Jury will act as Foreign Judge and will be required to complete a Foreign Judge's Report. The Foreign Judge must be identified in the Schedule and should be whenever possible a 5* Judge.

9. Appointment of Judges and Technical Delegate

9.1 **For FEI Championships and Games**, the President and the other members of the Ground Jury are recommended by the JSP from the FEI list of 5* Judges and appointed by the FEI Dressage Technical Committee/FEI HQ. The President and all members will judge all Competitions. All Judges must be of different nationalities.

9.2 FEI Championships for Youth

For FEI Continental Championships for U25, Young Riders, Juniors, Children and Pony Riders, the President and the other members of the Ground Jury are appointed by the FEI with the cooperation of the Dressage Technical Committee from the FEI list of 5* and 4* Judges. One (1) member of the JSP is appointed by the FEI with the purpose of supervision of the judging process for the European Youth Championships.

When FEI Championships for Youth are held jointly a Ground Jury of five (5) members including one (1) President shall be appointed by the FEI from the list of 5* and 4* Judges for each FEI Continental Championship.

9.3 **For FEI World Cup™ Dressage Finals**, the President and the other six (6) members are appointed by the FEI with the cooperation of the Dressage Technical Committee from the list of 5* and 4* Judges.

9.4 **For FEI World Cup™ Dressage Qualifiers** the Judges must be from the list of 5* and 4* Judges. One (1) 3* Judge may be exceptionally appointed only with previous approval by the FEI. The Foreign Judge will be selected by the FEI. Refer to the FEI World Cup™ Dressage Rules.

9.5 **For Regional Games under the patronage of the International Olympic Committee**, the President and the other four (4) members of the Ground Jury are appointed by the FEI with the cooperation of the Dressage Technical Committee from the FEI lists of 5* and 4* Judges.

9.6 **For FEI Regional and FEI Continental Championships** held outside the European Continent, the President and the other members of the Ground Jury are appointed by the FEI from the lists of 5* and 4* Judges.

9.7 **For CDIOs**, the President and the other members of the Ground Jury are appointed by the OC, in agreement with the FEI, from the FEI lists of 5* and 4* Judges.

At CDIOs at least three (3) out of five (5) Ground Jury members have to be of foreign nationality and of different nationalities.

CDIOs for Youth, ref. Annex 7.

9.8 **For CDI5***, the President and the other members of the Ground Jury are appointed by the OC, in agreement with the FEI, from the FEI lists of 5* and 4* Judges. Minimum three (3) 5* Judges and at least three (3) foreign Judges of different nationalities shall be appointed. Minimum one (1) 4* Judge must be appointed.

9.9 **For CDI4***, the President and the other members of the Ground Jury are appointed by the OC, in agreement with the FEI, from the FEI lists of 5* and 4* Judges. Minimum two (2) 5* Judges and at least three (3) foreign Judges of different nationalities shall be appointed. Minimum two (2) 4* Judges must be appointed.

9.10 **For CDI3***, the President and the other members of the Ground Jury are appointed by the OC, in agreement with the FEI, from the FEI lists of 5*, 4* and 3* Judges. One (1) 3* Judge is mandatory to judge in at least one (1) competition in the big tour in Western Europe and recommended outside Western Europe. However no more than two (2) 3* Judges should be

appointed in a Ground Jury of five (5). Minimum one (1) 4* Judge must be appointed. At least three (3) Judges should be foreign and of different nationalities. Outside Western Europe, two (2) of the three (3) foreign Judges may be of the same nationality.

Small tour Competitions. When scheduled at CDIs and CDI-Ws outside Western Europe, Prix St Georges and Intermediate I level Competitions may exceptionally be judged by a Ground Jury consisting of three (3) members upon prior approval by the FEI. For Western Europe, this may only be granted in cases of special circumstances such as illness, etc, and only with the previous permission of the FEI. With three (3) Judges only, the Judges must be seated as follows: two (2) on the short side (at C and at either H or M) and one (1) on the opposite long side (B or E). At least one (1) Judge must be foreign. One (1) 2* Judge may be on the Ground Jury. The minimum requirements are the same for Medium tour Competitions.

- 9.11 **For CDI2*.** Minimum three (3) Judges. The President and the other members of the Ground Jury are appointed by the OC from the FEI lists of 5*, 4* and 3* Judges. One (1) active (as determined by the NF) national Grand Prix Judge from the host NF may also be appointed in a Ground Jury of five (5). In a Ground Jury of five (5) members at least two (2) have to be foreign of different nationalities. In a Jury of three (3) members at least one (1) has to be foreign.
- 9.12 **For CDI1*.** Minimum three (3) Judges. The President and the other members of the Ground Jury are appointed by the OC from the f FEI lists of 5*, 4*, 3* and 2* Judges. One (1) active (as determined by the NF) national Grand Prix Judge from the host NF may also be appointed in a Ground Jury of three (3), and two (2) in a Ground Jury of five (5). In a Ground Jury of five (5) members at least two (2) have to be foreign of different nationalities. In a Ground Jury of three (3) members at least one (1) has to be foreign.
- 9.13 **For CDIU25.** Minimum three (3) FEI Judges. The President and the other members of the Ground Jury are appointed by the OC from the FEI lists of 5*, 4* and 3* Judges. One (1) active (as determined by the NF) National Grand Prix Judge from the host NF may also be appointed in a Ground Jury of five (5). In a Ground Jury of three (3) members there must be at least two (2) Judges of different foreign nationalities and in a Ground Jury of five (5) members there must be at least two (2) foreign Judges of different nationalities.
- 9.14 **For CDIY/CDIJ/CDIP/CDIch.** Minimum three (3) Judges. The President and the other members of the Ground Jury are appointed by the OC from the list of 5*, 4*, 3* and 2* Judges. In a Ground Jury of five (5) members, one (1) active (as determined by the NF) National Judge from the host NF may also be appointed. In a Ground Jury of three (3) members, there must be at least two (2) Judges of different foreign nationalities and in a Ground Jury of five (5) members there must be at least two (2) foreign Judges of different nationalities. Outside Europe, there must be at least one (1) foreign Judge in a Ground Jury of three (3) members.
- 9.15 **For CDIYH.** There must be a Ground Jury of a minimum of three (3) Judges from the FEI list of approved Judges for Young Horse Dressage Events. Refer further to Directives for International Dressage Competitions for five (5), six (6) and seven (7)-year old Horses.
- 9.16 **For CDIAm.** Minimum three (3) Judges. The President and the other members of the Ground Jury are appointed by the OC from the FEI lists of 5*, 4* and 3* Judges. In a Ground Jury of five (5), at least two (2) foreign judges of different nationalities. In a Ground Jury of three (3), at least one (1) foreign judge. One (1) active (as determined by the NF) National Grand Prix Judge from the host NF may be appointed in a Ground Jury of three (3) and two (2) in a Ground Jury of five (5).
10. Not more than two (2) 3* Judges may be appointed to the same Ground Jury of five (5) members. If the Ground Jury by special permission of the FEI consists of three (3) Judges, only one (1) 3* Judge is allowed.

11. **Maximum number of combinations judged per day.** At any Event a Judge may not be called upon to Judge more than approximately forty (40) Athletes a day.
12. The President(s) and/or the FEI nominated Foreign Judge must arrive in time for the Horse inspection. In the case this is not possible, they have the possibility to delegate this to another member of the Ground Jury in accordance with FEI and the OC.
13. In case a member of the Ground Jury becomes incapable to judge before or during the Competition (parts of the test or more), their scores will be removed from the result list of the whole Competition.
14. For necessary qualifications of Judges refer to Annex Judges and FEI Education System for Dressage Judges.
15. **Technical Delegate.** For Championships, Games and Series' Finals, the FEI will appoint a Technical Delegate in addition to the Ground Jury. If FEI Championships for Youth Athletes are held at the same time as FEI Championships for other youth categories, one (1) Technical Delegate may act for both FEI Championships. In such case, the appointment of an assistant Technical Delegate is recommended.

ARTICLE 438 JUDGES SUPERVISORY PANEL (JSP)

1. The purpose of the JSP is to ensure fair judging.

~~The purpose of the JSP is to ensure fair judging.~~

2. The JSP should consist of three (3) members, ideally two (2) judges and one (1) trainer/Athlete. All JSP members must be independent and experienced (judges: 5*), well respected and diplomatic, adhere to the judges' codex, have integrity and communication skills. Active judges, trainers and Athletes must take time off judging, riding and training participants for equestrian events as specified in the JSP Job description during their term as JSP members. There can be a maximum of one (1) JSP member per NF on the same panel.
3. A Judges Supervisory Panel (JSP) is mandatory for Olympic Games, World and Continental Championships on Grand Prix level and World Cup Finals. A JSP may be present at all CDIs, CDIOs and other Championships/Games than those listed above.
 - 3.1 A JSP member must be appointed by the FEI for European Championships for Youth.
4. The JSP may correct definite technical mistakes and counting errors. The JSP may not set marks outside the range of the judges' given marks. Corrections may be made both to lower and raise marks. The JSP must inform the judges immediately after the competition which marks have been changed. A signed form with the correction will be added to the normal sheets and made available to the Athletes, and given to the Judge, whose mark has been changed.
5. If a judge's final score for a Horse/Athlete combination varies (above or below) by five (5)% or more from the average of the scores of the other judges for the same combination, the JSP may, by unanimous decision, change that particular score to be the same as the next closest score.
6. At events, the JSP should have a good view of the entire arena and be provided with computer screens showing the judges' marks instantly, as well as video of all the rides, which can be rewound and re-watched during each test.
7. JSP members are appointed for two (2) years periods. They may be reappointed for an unlimited number of periods. There is no age limit for JSP Members.

ARTICLE 439 — APPEAL COMMITTEE

ARTICLE 440 ABUSE OF HORSES

The FEI GRs refer to Abuse of Horses and such rules and regulations are applicable to all FEI Dressage Events.

ARTICLE 441 VETERINARY COMMISSION AND FEI VETERINARY DELEGATE

1. The composition of the Veterinary Commission, which is compulsory for Regional and Olympic Games, FEI World Cup™ Finals, all FEI Championships and CDIOs and the appointment of its President and members must be in accordance with the Veterinary Regulations.
2. At CDIIs, the presence of a veterinarian, to be regarded as the FEI Veterinary Delegate appointed by the OC, is required in accordance with the Veterinary Regulations.

ARTICLE 442 STEWARDS

1. The FEI GRs refer to the Stewards and such rules and regulations are applicable to all FEI Dressage Events.
 - 1.1. The Chief Steward is responsible for the organisation of stewarding throughout the Event.
 - 1.2. The Chief Steward must ensure that stable security is adequate for the level of Event and that sufficient Stewards are available.
 - 1.3. The Chief Steward, the Organising Committee, Ground Jury and Technical Delegate have to ensure the smooth running of all defined functions during a Competition such as opening and closing ceremonies or any required organised function within the Competition.
 - 1.4. For Championships and Games, the FEI will appoint one Level 3 Foreign Chief Steward. At least two minimum Level 1 Stewards must be appointed by the OC in addition.
 - 1.5. At CDIIs and CDIOs, one Level 2 (Chief Steward) and at least one minimum Level 1 Steward must be appointed by the OC.
 - 1.6. At CDIO5* one Level 3 Steward (Foreign Chief Steward) and at least two minimum Level 1 Stewards must be appointed by the OC.
 - 1.7. ~~Stewards~~. According to the size (number of overall competitors at the Event) and type of Event, a sufficient number of Stewards must be appointed by the OC in consultation with the Chief Steward, prior to the Event

All Stewards at international Events should preferably hold at least a Level 1 status. If this is not the case, they must have received formal instruction in their specific responsibility from the Chief Steward.

CHAPTER IV HORSE INSPECTIONS AND EXAMINATIONS, MEDICATION CONTROL AND PASSPORTS OF HORSES

ARTICLE 443 HORSE INSPECTIONS, EXAMINATIONS AND PASSPORTS OF HORSES

Horse inspections and Examinations must be conducted in accordance with the Veterinary Regulations. For passports of Horses refer to the FEI GRs.

ARTICLE 444 MEDICATION CONTROL OF HORSES

The Medication Control of Horses must be conducted in accordance with the FEI GRs, the Veterinary Regulations, the Equine Anti-Doping and Controlled Medication Regulations and any other applicable FEI Rules or Regulations.

CHAPTER V CDIOS, SENIOR WORLD, CONTINENTAL, REGIONAL, INDIVIDUAL AND TEAM FEI DRESSAGE CHAMPIONSHIPS AND GAMES

ARTICLE 445 CDIOS

1. Participation

- 1.1 A CDIO is an Official International Dressage Event with teams and individuals.
- 1.2 In principle CDIOS are open to Athletes from an unlimited number of foreign nations.
- 1.3 However, in order for a CDIO to receive that status, at least six (6) teams must be invited, including host nation, (one (1) team per NF) and at least three (3) teams must have participated.
- 1.4 No additional individual Athletes from the same NF are allowed to take part in addition to the teams at CDIOS. All invited Athletes must be given the same privileges.

Categories of CDIOS:

- CDIO2***: A CDIO with prize money up to CHF 32'999
- CDIO3***: A CDIO with prize money up to CHF 50'000
- CDIO4***: A CDIO with prize money within the range CHF 50'001 – 99'999
- CDIO5***: A CDIO with prize money exceeding CHF 100'000

- 2. **Priority.** All CDIOS take precedence over CDI Events. CDI-Ws take precedence over CDIs 3* to CDIs 5*.
- 3. **Teams.** An official Grand Prix Team Competition must be scheduled. CDIO2* may Schedule only Intermediate A and B tests. The teams must consist of a maximum of four (4) and of a minimum of three (3) Athletes of the same nationality. Reserve combinations are not permitted.

4. Individual Athletes

NFs which cannot send a team, may enter one (1) or two (2) individual Athletes, each with one (1) or two (2) Horses. Each Athlete may ride only one (1) Horse in the Grand Prix.

5. Formula and Tests

5.1 Championship Formula:

<u>Competition Formula:</u>	<u>Test:</u>	<u>Participation:</u>
1. Team Competition:	Grand Prix test	All
2. Individual Competition:	Grand Prix Special	Thirty (30) best from Grand Prix
<i>(If all four Athletes of a team qualify, they may all participate)</i>		
3. Individual Competition	Grand Prix Freestyle	Fifteen (15) best from Grand Prix Special

(Only the three (3) best Athletes per country may participate)

A rest day to be scheduled, preferably between Competitions two (2) and three (3).

5.2 Nations Cup Formula:

Please refer to the FEI Dressage Nations Cup Rules (CDIOs3*/4*/5*).

5.3 CDIO2* Formula

Competition Formula:	Test:	Participation:
1. Team Competition	Intermediate A	All
2. Individual Competition	Intermediate B	up to thirty (30) best from Intermediate A

5.4 **Consolation Competition:** the OC may Schedule a Consolation Competition (of the relevant CDIO level) judged by only three (3) Judges. This Competition will however not entail World Dressage Ranking List points and any prize money offered must be of lower level than for the Individual Competitions. See Article 422 of the Dressage Rules.

6. Draw

Refer to Article 425 of the Dressage Rules.

7. Ground Jury

7.1 The President and the other members of the Ground Jury are appointed by the NF and the OC, in agreement with the FEI, from the FEI lists of 4* and 5* Judges. The Foreign Judge is appointed by the FEI and acts on behalf of the FEI for CDIO5*s and CDI5*s.

7.2 At CDIOs at least three (3) out of five (5) Ground Jury members have to be of foreign and of different nationalities. In a Ground Jury of seven (7), four (4) members have to be foreign, two (2) may be of the same nationality.

8. Expenses and Privileges for Athletes, Grooms, Chefs d'Equipe and Team Veterinarians

CDIO2*: The OC is free to supply NFs a total sum towards covering stabling and fodder, meals and accommodation expenses as per agreement with the FEI.

CDIO3*: The OC is free to supply NFs a total sum towards covering stabling and fodder, meals and accommodation expenses as per agreement with the FEI.

CDIO4*: Expenses and Privileges: accommodation, three (3) meals/day, stabling and fodder.

CDIO5*: Expenses and Privileges: accommodation, three (3) meals/day, stabling and fodder.

Expenses and privileges must be given from the day before the Horse inspection to the day after the last Competition of the Event.

ARTICLE 446 FEI CHAMPIONSHIPS- ORGANISATION

1. Every four (4) years, in the event year between the Olympic Games, the FEI World Individual and Team Dressage Senior Championship is allocated in accordance with the priority as set forth in the FEI GRs.
2. Every two (2) years, in the uneven years between the Olympic Games, the FEI Continental Individual and Team Senior Dressage Championship is allocated in accordance with the priority as set forth in the FEI GRs.

3. These FEI Championships must be organised so as to conform to the FEI GRs and the Rules for Dressage Events (Chapter II above, except where specifically modified below). At least six (6) foreign nations or regional teams outside Europe must be represented by Teams.
4. The Grand Prix (Team Championship Competition) the Grand Prix Special (Individual Competition) and the Grand Prix Freestyle Test (individual Competition) comprise the Competitions for the FEI Championships.
- 4.1 Medals will be awarded for all three (3) Competitions.

4.2	<u>Competition Formula:</u>	<u>Test:</u>	<u>Participation:</u>
	1. Team Competition:	Grand Prix test	All
	2. Ind Championship Comp	Grand Prix Special	Thirty (30) best from Grand Prix
	<i>(If all four (4) Athletes of a team qualify, they may all participate)</i>		
	3. Ind Championship Comp	Grand Prix Freestyle	Fifteen (15) best from Grand Prix Special
	<i>(Only the three (3) best Athletes per country may participate)</i>		

A rest day to be scheduled, preferably between Competitions two (2) and three (3).

For all Championships (both Senior level and below), an Athlete must have completed the first test in order to continue in Competition.

No team Competition other than the Team Championship is allowed on the occasion of a Championship, neither is an Athlete allowed to ride more than one (1) Horse in each Competition (compare Articles 420 and 422 of the Dressage Rules).

The OC may Schedule a consolation Grand Prix Competition judged by only three (3) Judges. This Competition will however not entail World Dressage Ranking List points or qualification for Olympic Games, etc. and any prize money offered must be of lower level than for the other Competitions. See Article 422 of the Dressage Rules.

5. These FEI Championships take precedence over all other international Dressage Events.
6. No CDIO will be authorised during the two (2) weeks which precede any of these FEI Championships (for FEI Continental Championships, on the Continent where the FEI Championship is to be held). Exceptions to this rule may be made by the Board of the FEI in agreement with the OC of the Championship concerned.

ARTICLE 447 GROUND JURY AND TECHNICAL DELEGATE

1. **Ground Jury:** for all FEI Championships (except for FEI Championships/Games on Grand Prix Level and Olympic Games – see Article 437.9.1) and Regional Games, the President and the other members of the Ground Jury must be appointed by the FEI and chosen from the FEI list of 5* and 4* Judges (Article 437 of the Dressage Rules).
If a Prix St Georges, Intermediate I or Intermediate II Competition is scheduled, a separate Ground Jury must be invited.
2. **Foreign Technical Delegate:** a Technical Delegate who is not a member of the Ground Jury, shall be appointed for Regional Games and FEI Regional Championships when the FEI so deems it necessary.
- 2.1 For FEI Continental Championships for Seniors, FEI World Championships, Olympic Games and FEI World Cup™ Dressage Finals, the Technical Delegate is appointed by the FEI. They must

be a person other than the President or member of the Ground Jury and will be selected from the FEI list of Dressage Technical Delegates.

- 2.2 A list of FEI Technical Delegates qualified to officiate at FEI Continental Championships for Seniors, FEI World Championships, Olympic Games, FEI World Cup™ Dressage Finals, FEI Championships for Young Riders and Juniors and FEI /World Breeding Federation for Sport Horses (WBFSH) World Breeding Championships will be maintained by the FEI.
- 2.3 The Technical Delegate must, in coordination with the OC and Chief Steward, check and approve, in advance, the preparations for the Event. The Technical Delegate must approve the technical and administrative arrangements for the conduct of the Event: for the examinations and inspections of Horses; for the accommodation of Horses and Athletes and for the stewarding of the Event. Technical Delegate will supervise the briefing(s) and the conduct of all technical personnel. Technical Delegate will investigate all and report to and advise the Ground Jury on any decisions they are required to take. Until Technical Delegate has reported to the Ground Jury that they are satisfied with all the arrangements, the authority of Technical Delegate shall be absolute. Thereafter Technical Delegate will continue to supervise the technical and administrative conduct of the Event and will advise and assist the Ground Jury, the Veterinary Commission and the OC. Technical Delegate should, whenever possible, be foreign.

The qualifications for Technical Delegates are as follows:

- to be a past or present FEI 4*/5* Dressage Judge and having participated in a FEI Seminar for Technical Delegates or having been appointed by the Dressage Technical Committee on the grounds of their extensive knowledge of Dressage and the specific rules and having participated in a FEI Seminar for Technical Delegates.

ARTICLE 449 PARTICIPATION

1. After approval by the FEI, the Schedules, conditions and invitations are sent to the appropriate NFs for the World Dressage Championship and the Continental Dressage Championship either by the NF of the country where the Championship is to be held or by the OC of the Event.

1.1 Entries

- 1.1.1 Entries for FEI World and Continental Championships must be made in accordance with the FEI GRs Art. 116.

1.2. Substitutions of Athletes/Horses:

Following receipt of definite entries, substitution of Horse(s) and Athlete(s) from the Nominated list, may be made with the agreement of the OC. The OC must print in the Schedule the latest date for substitution of Horse(s) and Athlete(s), which may not be later than two (2) hours before the Horse inspection.

2. Teams

An NF may enter one (1) team. Each team is composed of three (3) Athletes and three (3) Horses or four (4) Athletes and four (4) Horses. Reserve combinations are not allowed. In a team composed of four (4) Athletes the three (3) best scores only count for the team result.

3. Individuals instead of teams

- 3.1 NFs which cannot send a team, may enter one (1) or two (2) individual Athletes, each with one (1) or two (2) Horses. Each Athlete may ride only one (1) Horse in the Grand Prix.

- 3.2 The NF organising the Championship is entitled to send maximum two (2) additional Athletes with one (1) Horse each to participate in the Small Tour, if scheduled: Prix St. Georges and/or Intermediate I Competitions.
- 3.3 Should more than approximately forty (40) entries be received for the Grand Prix, the OC is obliged to divide the Competition in sections to be ridden on consecutive days. In such a case, the sections will be judged by the same Ground Jury.
4. **Special conditions** for Competitions held in connection with the FEI Championships:
- 4.1 NFs which have entered a team or only one (1) or two (2) individual Athletes, each with one (1) Horse only in the FEI Championships, may enter one (1) or two (2) additional Athletes with a total of two (2) additional Horses in the Small tour; Prix St. Georges and the Intermediate I, if scheduled.
- 4.2 An Athlete competing in the Grand Prix may ride only the same Horse in the Intermediate Number II Competition if scheduled.
- 4.3 The expenses and privileges for the additional Athletes and Horses will be the responsibility of the respective NF. The OC is free to contribute to these expenses and privileges.
5. **Draw:** The draw for starting order
- | | |
|-------------------------|--|
| Team Competition | Refer to Article 425 of the Dressage Rules |
| Individual Competitions | Refer to Article 425 of the Dressage Rules |

ARTICLE 450 QUALIFICATION CRITERIA

The World and Continental Dressage Championships for Seniors are open to all Athletes eligible according to established qualification criteria as published by the FEI.

ARTICLE 451 EXPENSES AND PRIVILEGES – ATHLETES, GROOMS, CHEF D’EQUIPE AND TEAM VETERINARIAN

1. Accommodation, three (3) meals/day, stabling, fodder and travel allowance shall be extended to Athletes, grooms, Chefs d’ Equipe and team veterinarians.
2. OCs are responsible for the stabling and fodder expenses of Horses during the period of the Event.
3. OCs are also responsible for the transportation of all Judges, , Technical Delegates, Chief Stewards and official teams, including Chefs d'Equipe, team members and individual Athletes, grooms and Horses during the period of the Event in case of venue and accommodation/stabling being separate.
4. The Chefs d'Equipe are responsible for the behaviour of their teams and/or individuals throughout the Event. They and their NF are responsible for any damages that occur. Chefs d’Equipe should be offered accommodation together with their Athletes.

ARTICLE 452 CLASSIFICATION

1. **The Team Classification** is decided as follows: In all team Competitions the winning team is the one (1) having the highest total points of their three (3) best Athletes, the second placed team is the one (1) with the next highest total points and so on.

Ties.

In case of equality of points, the highest ranked team is the one whose lowest classified Athlete out of the three (3) has the best result.

2. **The Individual Classifications** are decided as follows:

In all Competitions the winner is the Athlete having obtained the highest final percentage, the second placed Athlete is the one (1) with the next highest total and so on.

Ties. In case of equality of percentage for the first three (3) places, the highest total median score of the Judges will decide the placing. The median score is the middle number. To calculate the median of a set of scores, the scores need to be put in ascending numerical order. E.g. 68.5% - 69% - **70%** - 70.5% - 71%; 70% is the median score in this case.

In case of equality of percentage for remaining places, the Athletes are given the same placing.

In case of equality of percentage in a Freestyle Test, the higher artistic marks will decide on the better placing. Should the artistic mark be the same the mark for harmony shall decide. If still tied the mark for choreography shall decide.

There will be no adding of percentages from the team Competition and individual Competitions, but all Competitions start from zero (0) i.e. all Athletes will start each Competition with zero (0) points.

ARTICLE 453 PRIZES AND PRIZE MONEY

1. Prize money. The FEI GRs refer to Prizes and Prize Money, which rules and regulations are applicable to FEI Dressage Events.

The eventual allotment of prizes for the FEI Championships must be set out in the conditions for the Competitions and sent out together with the invitations and Schedules for the Championship concerned.

2. **Medals.** FEI Medals will be awarded to all members who have competed (not necessarily completed) in the first three (3) teams in the Team FEI Championships and for the first three (3) individuals in the Individual FEI Championships. For possible ties, see above Article 452 of the Dressage Rules.

ANNEX 1 – YOUTH ATHLETES CATEGORIES

CHAPTER I INTRODUCTION

ARTICLE 1 GENERAL

Participation of Youth Athletes is an important element in the development of the Equestrian Sport in the world. The objective of the following set of Regulations is to standardise types of Events and Competitions for Youth Athletes throughout the world, taking into account specific conditions applying exclusively to them.

ARTICLE 2 PRIORITY OF RULES AND REGULATIONS

In all matters not covered by the Dressage Rules, the Statutes, the FEI GRs, the FEI VRs and all other relevant FEI Rules and Regulations shall apply.

CHAPTER II ELIGIBILITY AT INTERNATIONAL EVENTS

ARTICLE 3 GENERAL

1. For the age of Athletes, please refer to the FEI General Regulations.
2. Youth Championships: qualification criteria for all Youth Championships will be published on the FEI Website.
3. Scheduling possibilities: see Article 422

ARTICLE 4 PARTICIPATION

Athletes of the appropriate age may take part in FEI Competitions of more than one (1) Category, but in each Discipline, they may only participate in one (1) FEI Championship category in any one (1) calendar year (Ref. GRs)

4.1 YOUNG RIDERS

1. Young Riders may not compete both in an FEI Championship for Young Riders and in an FEI Championship or Games for Seniors in the same year.
2. A Young Rider who has taken part in an FEI Championship for Seniors or in Regional or Olympic Games - in Grand Prix - is no longer eligible to take part in any international Dressage Events for Youth.

4.2 JUNIORS

1. Juniors may not compete both in an FEI Championship for Juniors and in an FEI Championship or Games for Seniors in the same year.
2. A Junior who has taken part in an FEI Championship for Seniors or in Regional or Olympic Games - in Grand Prix - is no longer eligible to take part in any international Dressage Events for Youth.

4.3 PONY RIDERS

1. Pony height and measurements: ref. to VRs.
2. In any International Events, ponies must be at least six (6) years old.

4.4 CHILDREN

1. A Child may take part in the FEI Continental Dressage Championship for Juniors but is not allowed to take part in FEI Championships for Children and Juniors in the same year.
2. A Child has taken part in a FEI Continental Dressage Championship for Juniors, will no longer be eligible to compete in a FEI Championship for Children.
3. Outside Western Europe Children may compete on Ponies.
4. The FEI Children Championship is open to Horses which have not competed in a Grand Prix for Seniors during the preceding and/or current year.
5. Horses must not have competed in any Competition for Seniors during the Event at which the FEI Championship is being held.

4.5 U25

1. U25 Riders may not compete both in an FEI Championship for U25 Riders and in an FEI Championship or Games for Seniors in the same year.
2. A U25 Rider who has taken part in an FEI Championship for Seniors or in Regional or Olympic Games - in Grand Prix - is no longer eligible to take part in any international Dressage Events for Youth.

CHAPTER III INTERNATIONAL EVENTS

ARTICLE 5 INTERNATIONAL EVENTS

1. Types of Events.

The following types of Events for Youth Categories are established:

- International Events (CDIYs, CDIJs, CDIPs, CDICH-As, CDICH-B (borrowed horses), CDIU25s),
- Official International Events (CDIOYs, CDIOJs, CDIOps, CDIOChs, CDIOU25s).
- Continental Championships (CH-~~DEU~~-Y, CH-EU-J, CH-EU-P, CH-EU-Ch, CH-EU-U25)

2. International Events

- 2.1. A CDIY, CDIJ, CDIP, CDICH, CDIU25 is an International Event open to individual Athletes from the host country and from an unrestricted number of foreign countries.

No Team Competition may be held during a CDI for Youth Category.

3. Scheduling possibilities:

- 3.1 see Article 422

4. International Youth Events with borrowed Horses

- 4.1 Upon approval of the FEI, CDIOCh and CDIOCh may be organised in Dressage, using borrowed Horses provided by the OC.
- 4.3 Upon approval of the FEI, the following formula may be used by the OC at Events where borrowed Horses are provided:
 - 4.4 Each Athlete of the host country provides two (2) Horses. A draw is held to match foreign Athletes with host Athletes. Another draw takes place to allocate one (1) of the Horses of the host Athlete to the foreign Athlete. The Athlete of the host country rides the Horse which has not been allocated to the foreign Athlete; or
 - 4.5 Each Athlete of the host country provides two (2) Horses. Each foreign Athlete draws a Horse for each of the Athletes from the host country.

The remaining Horses are pooled together and are allocated to the foreign Athletes by means of a draw; or

- 4.6 A draw takes place to allocate all Horses provided by the OC to Athletes present; or
- 4.7 Each Athlete of the host country provides one (1) Horse. A draw takes place to match foreign Athletes with host country Athletes. Each Horse is ridden by a host country Athlete and by a foreign Athlete. In the first Competition, the host country Athlete rides their Horse first.

The following rules apply to all Competitions with borrowed Horses:

- 4.8 Sufficient reserve Horses must only be provided for foreign Athletes. Horses which are obviously unsuitable for foreign Athletes must be replaced by reserve Horses. Such a substitution may only be done with the approval of the Ground Jury.
- 4.9 Each Athlete will be given the opportunity to school the Horse obtained in the draw at least once, during a riding session lasting one (1) hour.
- 4.10 The OC will establish the Rules governing schooling sessions.
- 4.11 Horses must be allocated at least two (2) days before the first Competition.
- 4.12 Horses may only be ridden once daily for a maximum of one (1) hour.
- 4.13 The Horse must be ridden using the bit which they usually work with and in which they are presented at the time of the draw. The bit may be changed only with the agreement of the owner.
- 4.14 The following and above rules apply for Competitions with borrowed Horses which are run in accordance with paragraph 2.2.7 above, unless otherwise stated below.

5. Official International Events

- 5.1 A CDIOY, CDIOJ, CDIOP, CDIOCh, CDIOU25 is an International Event open to three (3) or more countries represented by teams. Exceptions may be approved by the FEI for countries outside Western Europe.
- 5.2 Number of CDIO for Youth per NF: see GRs, Art. 103.
- 5.3 It must include the official Competitions for teams and individuals as specified in the rules of the appropriate categories as set forth in the Dressage Rules.

- 5.4 A Team consists of three (3) or four (4) Athletes and Horses of which the results of the best three (3) count. An OC may choose to schedule a Team competition with Teams of two (2) or three (3) Athlete/Horse combinations. No reserve combinations are allowed.
- 5.5 NFs who cannot send a Team, may enter one (1) Individual when teams of two (2) or three (3) are invited, or up to two (2) individuals when teams of three (3) or four (4) are invited
- 5.6 NFs who have entered a team may be invited to enter additional individual Athletes at the discretion of the OC. This must be stated in the FEI approved schedule.
- 5.7 It is possible to organise more than one CDIO on a same Continent on same dates. No CDI or CDIO may be organised on the same continent at the same time as a Championship for a specific Youth category.

ARTICLE 6 CHAMPIONSHIPS

1. The Championships must be organised in strict accordance with the FEI GRs, the Dressage Rules, the present Annex, and as specified hereunder.
2. In principle, Championships can only be held if at least four (4) nations are represented, except outside of Europe where they may be held with any number of regional teams from at least two (2) countries (including the host nation). An NF which withdraws after the closing date for the entries and before the start of the FEI Championship is, however, considered as represented.
3. The FEI Championships must be held sometime during a long school holiday.
4. The FEI Championships must be held outdoors unless weather conditions demand an indoor Competition.
5. No entry fee nor starting fee may be charged unless cash prizes are awarded. The FEI may stipulate a maximum global entry fee annually for these FEI Championships.
6. Medals will be awarded for Teams and Individuals at FEI Continental Championships and other FEI Championships as approved by the FEI.

CHAPTER IV OTHER SPECIFICATIONS

ARTICLE 7 EXPENSES AND PRIVILEGES

1. **Events**

OC of Events open to Youth Athletes are free to offer and negotiate financial and accommodation assistance, either in hotels or youth hostels, or with private families, with the NFs of the invited Athletes.
2. **FEI Championships and CDIOs**
 - 2.1 NFs are responsible for the travelling expenses of their own Chefs d'Equipe, Athletes, grooms and Horses to and from the location of these FEI Championships and CDIOs.
 - 2.2 For the OCs, the same applies as under article 7.1 but with the following minimum to be included in the global entry fee:
 - Stabling and fodder for the Horses.
 - Possibility for the grooms to stay in the immediate vicinity of the stables.

If accommodation is not offered for free, then suitable accommodation should be arranged or recommended, and prices must be quoted in the Schedule.

- Article 132.1 of the FEI GRs (owners of Horses) apply.
- Agent and Veterinary fees for entering and leaving the frontier of the OC country and/or the show grounds to be arranged and paid by the OC.

- One main meal must be provided free of charge by the OC, preferably in the evening, for Athletes and Chefs d'Equipe (either on the show grounds or elsewhere).

2.3 Officials: see Dressage Rules and GRs.

3. All privileges are to be awarded from one day before the Horse inspection until one (1) day after the Event.

4. The Chefs d'Equipe are responsible for the behaviour of their teams and/or individuals throughout the Event. They and their NF are responsible for any damages that occur. If the Athletes are not lodged in private homes the Chefs d'Equipe must stay with their teams and/or individuals.

ARTICLE 8 PRIZES

1. Prize money and/or prizes in kind must be awarded in all Youth Categories events.

1.1 Children: Preferably prizes in kind at CDIs for Children. At FEI Championships only FEI medals and prizes in kind can be awarded; prize money is not allowed.

2. In all Events except FEI Championships, one (1) rosette and a prize in kind or a souvenir, if prize money is not given, must be awarded for each commenced four (4) Athletes with a minimum of five (5) prizes. It is recommended that stable plaques should be awarded to a minimum of the first four (4) individuals.

3. In FEI Championships, the following minimum number of awards must be presented:

3.1 In preliminary and in consolation Competitions, prize money and/or prizes in kind, plaques and rosettes at a rate of one (1) prize for each commenced four (4) Athletes with a minimum of five (5) prizes.

3.2 In the Team FEI Championship, FEI medals (see FEI GRs). In addition, prize money to Horse owners and/or prizes in kind, plaques and rosettes for each of the Athletes in the teams taking the first four (4) places.

3.3 In the Individual FEI Championship Competitions (Prix St. Georges and Young Riders Freestyle), FEI medals (see FEI GRs). In addition, prize money and/or prizes in kind, plaques and rosettes at a rate of one (1) prize for each commenced four (4) Athletes with a minimum of five (5) prizes.

3.4 At FEI Championships, the prize giving and medal ceremony should be given great importance and should be held in the arena.

3.5 All Chefs d'Equipe and Athletes should be presented with a souvenir or a plaque by the OC.

ARTICLE 9 SCHOOLING OF HORSES

Schooling of horses, refer to Article 422.3.6 and 428.

CHAPTER V CONTINENTAL AND REGIONAL CHAMPIONSHIPS

ARTICLE 10 ENTRIES

1. Refer to Article 449 of the Dressage Rules and FEI GRs. After the approval of the FEI, the Schedule together with the invitation, are sent to the appropriate NFs of the Continent or Region by the NF of the host country.

2. Teams

An NF may enter one (1) team. Each team is composed of three (3) Athletes and three (3) Horses or four (4) Athletes and four (4) Horses. Reserve combinations are not allowed.

In a team composed of four (4) Athletes, only the three (3) best scores count for the team result. Each Athlete may ride only one (1) Horse in the FEI Championship. The OC must extend an invitation to the Chef d'Equipe who will be given the same privileges as the Athletes. However, outside Europe, the NFs concerned may determine the number of teams and the regional basis for team representation.

3. Individuals in addition to teams

No individuals in addition to a team are allowed.

4. Individuals instead of teams

An NF which cannot send a team may enter one (1) or two (2) individual Athletes, each with one (1) Horse.

5. **Grooms.** NFs are entitled to send one (1) groom for each Horse.

6. NFs must make their entries in two (2) phases in accordance with Article 449 of the Dressage Rules.

ARTICLE 11 QUALIFICATIONS

1. Horses

1.1 The qualifications must strictly comply the qualification criteria published on the FEI website.

1.2 In the event of the FEI Championship being held at the same time or almost at the same time and at the same place as a FEI Championships for Seniors, CDIO or CDI, no Horse may compete or be ridden by a Youth Athlete age category as well as by a Senior during these Events.

2. Athletes

The qualifications must strictly comply with the qualification criteria published on the FEI website.

ARTICLE 12 COMPETITIONS AND TESTS

1. Young Riders, Juniors, Pony Riders and U25.

1.1 The Competitions will comprise:

The Preliminary Dressage Competition

Optional. Declarations at the discretion of the Chef d'Equipe. Should a Preliminary Dressage Test not be scheduled, there must be time allocated for Athletes to familiarise with the main arena before the Team test.

A. The Team Dressage FEI Championship

A1 This is the Team Dressage Competition.

Test to be ridden: Team Dressage test. Compulsory for all Athletes.

B. Individual Dressage FEI Championships

The Individual test and the Freestyle Test are the individual FEI Championships competitions.

B1 Individual Test Final

The Individual test is the first individual FEI Championship competition open to all Athletes who completed the Team test. If a team has four (4) Athletes, they may all participate. An Athlete must have completed the first test in order to continue in Competition.

B2 Freestyle Test Final

The Freestyle Test is the Individual Freestyle FEI Championship competition which is limited to and compulsory for the overall best eighteen (18) out of Competition B1 who qualified, including those who tie for 18th place. Only the three (3) best Athletes per country may participate. In case of equality of percentage in a Freestyle Test, the higher artistic marks will determine the better placing.

There will be no adding of percentages from the team test and individual test but all Competitions start from zero (0).

In case of certified illness of Athlete and/or Horse, the next Athlete/Horse combination in the respective classification will move up to fill the number of combinations allowed. See Article 424 of the Dressage Rules.

In CDI/FEI Championships Competitions where four (4) Athletes have qualified for one (1) NF and only three (3) Athletes may participate within the first eighteen (18) in cases of certified illness of one (1) of the qualified Athletes/Horses, the 4th Athlete will replace one (1) of the qualified Athletes. See also Article 424 of the Dressage Rules.

The Team test and the Individual test are held under the rules contained in Chapter II of the Senior Dressage Rules, except where stated differently under this Chapter.

FEI Championship Formula

Day 1 and 2	Team test	All
Day 3 and 4	Individual Test	All
Day 5	Freestyle Test	Eighteen (18) best from Individual Test (including ties for 18 th place or highest placing).

A consolation class should be offered if no extra day is added to the total length of the Event. Participation is optional.

2. Children.

2.1 The Competitions will comprise:

Preliminary Competition, compulsory for all Athletes – FEI Preliminary B Test for Children.

A. The Team Dressage FEI Championship

A1 This is the Team Dressage Competition.

Test to be ridden: Team Dressage test. Compulsory for all Athletes. An Athlete must have completed the first test in order to continue in Competition.

B. Individual Dressage FEI Championships

The Individual test is the individual FEI Championships competition.

B1 Individual Test Final

Open to and compulsory for the best eighteen (18) Athletes/Horses of the Children Team Competition. The three (3) best Athletes per country may participate including those who tie for the 18th placing.

Consolation Competition

Open to Athlete not competing in the Individual FEI Championship – Optional - FEI Preliminary B Test for Children.

ARTICLE 13 TEAM AND INDIVIDUAL CLASSIFICATION

Refer to Article 434 of the Dressage Rules.

ARTICLE 14 PRIZES AND PRIZE MONEY

Prize money. The FEI GRs refer to Prizes and Prize Money. The eventual allotment of prizes for the FEI Championships must be set out in the conditions for the Competitions and sent out together with the invitations and Schedules for the FEI Championship concerned.

Medals. FEI Medals will be awarded for the first three (3) teams in the Team FEI Championships and for the first three (3) individuals in the Individual FEI Championship and the Individual Freestyle FEI Championship.

ANNEX 2 – INTERNATIONAL DRESSAGE JUDGES

1. Categories

Judges are divided into four (4) categories: 2*, 3*, 4* and 5*

2. Languages

To speak at least English.

3. NF support

All FEI Judges require NF support for promotion and to remain on FEI list. Refer to FEI GRs.

4. Number of Judges

Number of FEI Judges for different regions will be dependent upon the number of international Events and their level held in the region and decided by the FEI.

5. Appointment at Events

The Rules for the appointment of Judges are set forth in Articles 437 and 446 of the Dressage Rules.

6. Qualifications and minimum requirements

The qualifications and minimum requirements for 2*, 3*, 4* and 5* Judges shall be published separately by FEI and shall be governed by the FEI Dressage Judges Education System.

A list of Technical Delegates qualified to officiate at all levels of Events will be maintained by the FEI.

The qualifications for Technical Delegates are as follows:

- to be a past or present FEI 4*/5* Dressage Judge and having participated in a FEI Seminar for Technical Delegates or being appointed by the Dressage Technical Committee on the grounds of their extensive knowledge of Dressage and the specific rules and having participated in a FEI Seminar for Technical Delegates.

General Conditions:

7. Reimbursement of Judges

Judges acting at an International Dressage Event will be paid as follows:

1. Reimbursement of all transportation costs. Judges should be offered a convenient travel solution, where total travel time and number of stops are minimised. Proposed travel plan must be submitted to the Judge for approval before bookings are made. For 6 and more hours non-stop flights, Business Class must be offered. In any case an individual air travel arrangement can be made between the OC and the Judge, e.g. higher judges per diem for travelling Economy Class.
2. Transportation - Suitable arrangements for airport and hotel transportation should be made in advance with the Judges. Transportation to and from the home airport or parking expenses at the home airport must be reimbursed by the OC.
3. Two (2) proper meals a day (in addition to breakfast). If OCs fail to do so, the Judges will be entitled to an additional daily allowance of EUR 25 per meal.
4. Accommodation - Accommodation provided in a minimum 3* hotel including breakfast (Western European standard) or equivalent outside Western Europe. No sharing with other Officials.

5. Per diem of EUR 120 per day, (remuneration for miscellaneous costs. This amount is net after relevant taxes being borne by the OC), the per diem is due for all officiating days (including rest days between competitions) plus one. At the discretion of the Official, the per diem for this additional day may be forfeited if the Official can conveniently travel on the officiating days.
6. Officials must have proper seating to watch the Competitions during the show whilst not officiating.

8. Conflict of Interest

No Judge may officiate at an Event if accepting such duties would cause a conflict of interest. Refer to FEI Codex for Dressage Judges (Annex 14), the FEI Officials' Code of Conduct and the FEI GRs.

Any violations to the Codex/Rules will be reported to the FEI and Dressage Technical Committee for the attention of and action by the FEI Legal Department.

9. Competing and/or training Judges

FEI Judges may not officiate at FEI Senior Competitions and also compete internationally on the same continent within the same calendar year. They must declare to the FEI via their NF by 1st January each year whether they wish to Judge or compete during that particular year.

FEI Judges may not judge Athletes they train on a regular basis, as referred to in Annex 14.

10. Inactivity

FEI Officials who have remained inactive for a period of more than three years and not having been recertified will be removed by the FEI from the list of FEI Dressage Officials. Further an Official who has been removed from the list due to inactivity/lack of recertification and wishing to be re-instated, is obliged to go through the qualification procedure before being eligible for re-instatement. Refer to the relevant FEI Education System.

11. Evaluation of Competitions

The President of the Ground Jury and/or the Competition/Foreign Judge must meet with Judges for evaluation when the total result differs more than five percent (5%) during a test. The meeting must take place within twenty four (24) hours after the Competition and with video of the concerned Athlete/Horse combinations for high Level Events. Video is recommended for low Level Events.

3*/4*/5* Judges may never act as secretaries or assistants to the President or any other member of a Ground Jury at international Dressage Events, but 2*, 3* and 4* Judges may sit in. 2* Judges may act as secretaries or assistants in Intermediate II and above.

For further information regarding conditions and Education System for FEI Dressage Judges, refer to the FEI Website – Dressage.

12. Rotation of Members of the Ground Jury for each Event

In a Ground Jury of three (3): Minimum one (1) new member every year.

In a Ground Jury of five (5) or seven (7): Minimum two (2) new members every year.

A judge may return to the same Event after two (2) years out.

A member of the Ground Jury may not be FEI Foreign Judge more than one (1) year in a row.

ANNEX 3 - DIRECTIVES FOR CDI/CDIO WITH BORROWED HORSES

International Events or Competitions may be organised with Horses borrowed by the host NF with the approval of the FEI. In such cases, the following conditions apply:

1. The Schedule must establish any additional conditions under which the Horses are borrowed, and the Competitions are organised.

A technical meeting must be organised before the Horse inspection and Draw to brief Chefs d'Equipe, Athletes, Horse owners and Officials on special conditions concerning both borrowed Horses and the organisation of the Event.

2. The OC will make available the necessary number of Horses (maximum of two -2- per Athlete). All Athletes should be able to ride the same number of Horses.
 - 2.1. All Horses must be capable of competing at the same level of Competition intended. No Horses listed on the World Dressage Ranking List may be used for Competitions with borrowed Horses.
 - 2.2. When there are not enough Horses available for Athletes to be supplied with two (2) Horses, there must be enough Horses for the number of Athletes plus at least three (3) or four (4) Horses as reserves.
 - 2.3. The draw for the Horses must take place as early as practicable at the latest, however, twenty four (24) hours before the start of the first Competition.
3. The Horse inspection must take place in front of the President of the Ground Jury/Foreign Judge and the President of the Veterinary Commission or the Veterinary Delegate and Chefs d'Equipe or a representative of the team, as well as the Athletes.

The Horses must be properly identified.

- 3.1. The owners of Horses will bring a bridle in accordance with Article 428 the Dressage Rules for use on their Horse. The President of the Ground Jury will note the bridles and bits for each Horse. These bridles and bits cannot be changed throughout the whole Event except by special permission of the President of the Ground Jury.
- 3.2. All reserve Horses must be inspected. Substitutions may only be made when authorised by the FEI Veterinary Delegate and the President of the Ground Jury and Foreign Judge/Technical Delegate. Team Horses may be exchanged within a team.
4. Draw: On the day or day before the start of the first Competition, a draw for the order of starting will take place in accordance with Article 425 of the Dressage Rules.
5. If there is a Final Individual Competition, it must be held as follows:
 - a) Qualification: open up to the top fifteen (15) Athlete/Horse combinations from of the team Competition, including those who tie for 15th place.
 - b) Order of Starting - Individual Final: Horses will be drawn from those which were placed with the respective Athlete in the top fifteen (15) in the qualifying Competition. If an Athlete draws the same Horse with which they qualified in the Team or other qualifying Competition, they have to redraw a Horse. Athletes may only start one (1) Horse.
 - c) Final Individual Classification: both Competitions (Qualifying and Individual Final) will count towards the Final Individual Classification. Percentage scores for each Competition will be added.
 - d) Ties: in the case of a tie for first place, the higher score in the Final Individual Competition will count for the better placing.

6. The OC should provide a reasonable number of reserve Horses to be used in case any Horse is found to be unfit to compete by the Veterinary Delegate/Commission after the draw. The reserve Horses must be named at the draw.
- 6.1. In the cases above, there must be a draw for the reserve Horse. These Horses must have passed the Horse inspection. Whatever the number of Athletes or Horses involved, there must be an attempt to have more Horses than the Athletes in the draw.
7. In cases where each Athlete draws two (2) or three (3) Horses for a whole Event, at least one (1) hour must be set aside for practice with the Horses, preferably the day before the Event begins. All Athletes will be able to warm-up and school their Horses for half an hour before their start time in each Competition (Competitions under paragraph 5 excluded). This must be supervised by the FEI Technical Delegate and the FEI Steward.
8. FEI Passports shall not be required, provided that only national Horses take part which can be positively identified with a document accepted by the NF.

ANNEX 4 - PAS DE DEUX

Pas de Deux is a Competition in international competitive Dressage where two (2) Athlete/Horse combinations are in the arena at the same time. *Pas de Deux* teams consist of two (2) Horses and two (2) Athletes each performing as both a team and individually, with the emphasis of the scoring being on the quality of the movements executed. *Pas de Deux* teams performs a self-choreographed test at a specified freestyle level.

Judging: Three (3) Judges, sitting at C. One (1) Judge judges one (1) of the combinations, one (1) Judge judges the other combination. Both Judges give only technical marks. The third Judge judges the artistic performance.

Test Sheets: Freestyle test sheet.

ANNEX 5 - STABLE SECURITY

1. Minimum FEI Stable Security

Requirements for CDIs, CDIOs, FEI Championships and Games refer to the FEI Veterinary Regulations.

ANNEX 6 – DRESSAGE ARENA

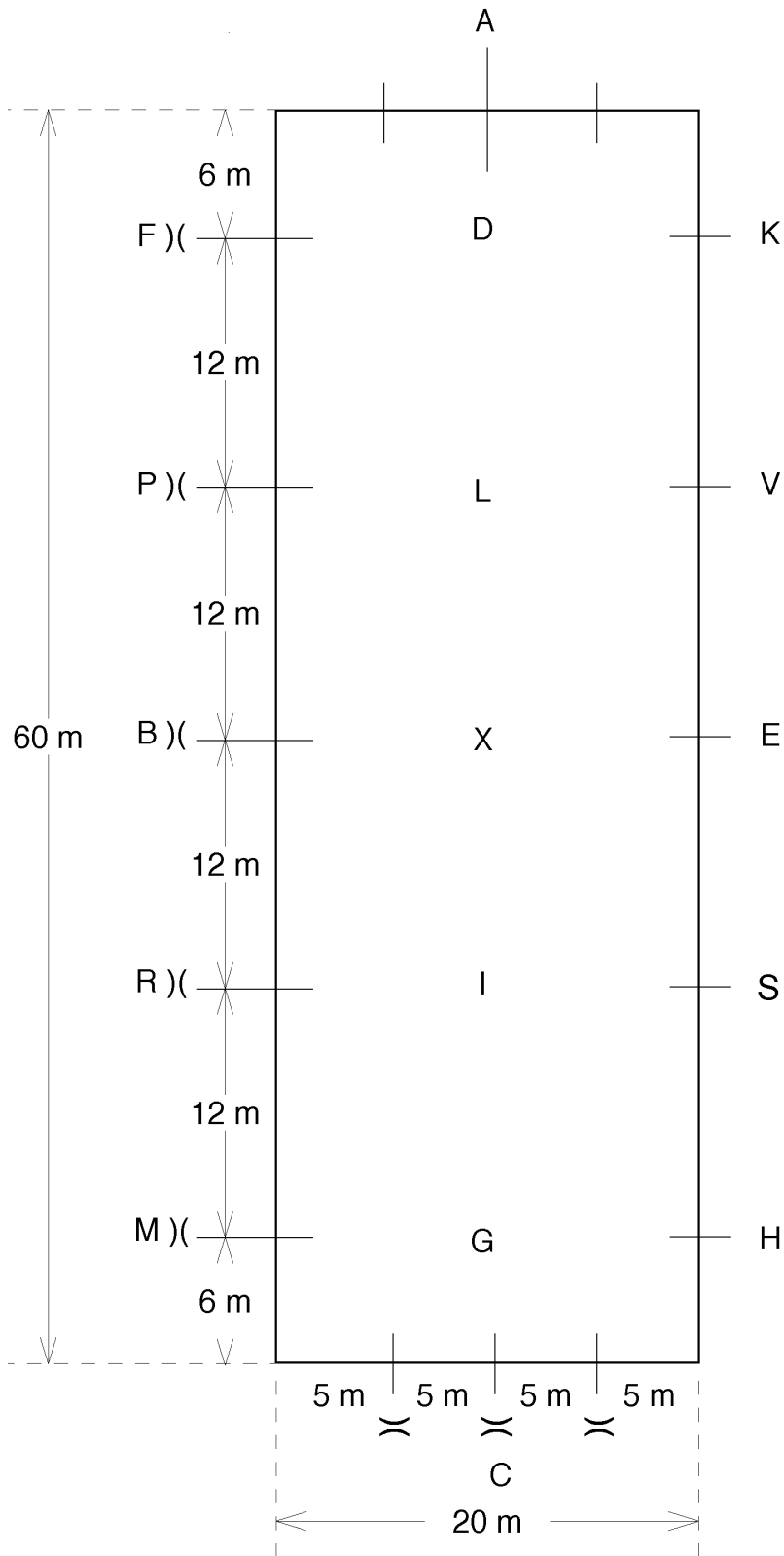

ANNEX 7 – CATEGORIES OF INTERNATIONAL DRESSAGE EVENTS

NOTE: The tables below are for informative purposes only. Should there be any conflict between the information contained in the tables and the FEI Rules and Regulations, the latter shall prevail.

	CDI-W	CDI5*	CDI4*	CDI3*
Participation	<p>Refer to the FEI Dressage World Cup™ Rules. All Athletes and Horses must be registered with the FEI. Horses per Athlete left to the discretion of OC.</p>	<p>Minimum of six (6) NFs including host NF, invited with a minimum of two (2) Athletes each <u>or</u> twelve (12) NFs with minimum one (1) Athlete each (min four (4) NFs including host NF when up to 15 Athletes invited.) An OC may never invite more home than foreign Athletes. Wild Cards see Article 423 of the FEI Dressage Rules. All Athletes and Horses must be registered with the FEI. To participate an Athlete/Horse combination must have achieved a minimum of sixty four percent (64%) in <u>Short Grand Prix</u>/Grand Prix at two (2) different CDI3*/CDI4*/CDI-W or CDIO3* /CDIO4* (Consolation Competitions do not count) after 01 January the previous year. Horses per Athlete left to the discretion of OC.</p>	<p>Minimum of six (6) NFs including host NF, invited with a minimum of two (2) Athletes each <u>or</u> twelve (12) NFs with minimum one (1) Athlete each (min four (4) NFs including host NF when up to 15 Athletes invited). An OC may never invite more home than foreign Athletes. Wild Cards see Article 423 of the FEI Dressage Rules. All Athletes and Horses must be registered with the FEI. Horses per Athlete left to the discretion of OC.</p>	<p>Minimum of six (6) NFs including host NF, invited with a minimum of two (2) Athletes each <u>or</u> twelve (12) NFs with minimum one (1) Athlete each (min four (4) NFs including host NF when up to 15 Athletes invited). An OC may never invite more home than foreign Athletes. Wild Cards see Article 423 of the FEI Dressage Rules. All Athletes and Horses must be registered with the FEI. Horses per Athlete left to the discretion of OC.</p>

DRESSAGE RULES - ANNEX 7 - CATEGORIES OF INTERNATIONAL DRESSAGE EVENTS

	CDI-W	CDI5*	CDI4*	CDI3*
Age	Athletes from sixteen (16) years.	Athletes from sixteen (16) years.	Athletes from sixteen (16) years.	Athletes from sixteen (16) years.
Horses	From eight (8) years. Short Grand Prix, Grand Prix Special, Grand Prix Freestyle. Small tour: seven (7) years.	From eight (8) years. Grand Prix, Grand Prix Special, Grand Prix Free Style. Small tour: seven (7) years.	From eight (8) years. Grand Prix, Grand Prix Special, Grand Prix Free Style. Small tour: seven (7) years.	From eight (8) years. Grand Prix, Grand Prix Special, Grand Prix Free Style. Small tour: seven (7) years.
Athletes	Athletes may only participate under the jurisdiction of the country from which they hold their passport.	Athletes may only participate under the jurisdiction of the country from which they hold their passport.	Athletes may only participate under the jurisdiction of the country from which they hold their passport.	Athletes may only participate under the jurisdiction of the country from which they hold their passport.
Competitions	FEI Short Grand Prix and FEI Grand Prix Freestyle compulsory. Medium and small tour may also be scheduled.	FEI Grand Prix including FEI Grand Prix Special and/or FEI Grand Prix Freestyle. Medium and small tour may also be scheduled.	FEI Grand Prix including FEI Grand Prix Special and/or FEI Grand Prix Freestyle. Medium and small tour may also be scheduled.	FEI Grand Prix including FEI Grand Prix Special and/or FEI Grand Prix Freestyle. Medium and small tour may also be scheduled.
Horse Passports	FEI Passport (see also FEI GRs Article 137)	FEI Passport (see also FEI GRs Article 137)	FEI Passport (see also FEI GRs Article 137)	FEI Passport (see also FEI GRs Article 137)
Entry fee	Max. CHF 500 for WEL. No restrictions for other CDI-W	Max. CHF 600	Max. CHF 525	No restrictions but must be in relation to prize money and hospitality.
Bedding-Straw	1 st bedding at OC expense for WEL. Optional OC or Athlete expense at other CDI-W	Bedding at OC expense	1 st bedding at OC expense	Optional OC or Athlete expense
Manure disposal	Max. EUR 40 per Horse	Max. EUR 40 per Horse	Max. EUR 40 per Horse	Max. EUR 40 per Horse
	For Events at the same venue over consecutive weekends ("Tours") max. EUR 40.- per Horse may be charged for the first Event of the Tour and max. EUR 20.- per Horse may be charged for each subsequent Event.			
Meals Athletes/grooms	At OC expense for WEL. Optional OC or Athlete expense for other CDI-W	At OC expense Breakfast + one meal	At OC expense Breakfast + one meal	Optional OC or Athlete expense
Accommodation	At OC expense for WEL. Optional OC or Athlete expense for other CDI-W	At OC expense	Optional OC or Athlete expense	Optional OC or Athlete expense

	CDI-W	CDI5*	CDI4*	CDI3*
Footing	According to AIDEO min. standard. (1)	According to AIDEO min. standard (1)	According to AIDEO min. standard (1)	No restrictions
Prize money	WEL <u>Short</u> Grand Prix: Minimum EUR 15'000. Grand Prix Freestyle: Minimum: EUR 50'000 No requirements for other CDI-W.	Minimum CHF 90'000. No maximum amount	Minimum CHF 24'000. Maximum CHF 89'999	No minimum amount. Maximum CHF 23'999
Ground Jury	Judges: 5 from FEI list; at least 3 foreign Judges of different nationalities. Minimum 3, 5* Judges WEL and FJ appointed by FEI. 7 FEI Judges may be used, at least 4 foreign and max. 2 from the same NF. Per diem for Judges: EUR 120*	Judges: 5 from FEI list; at least 3 foreign Judges of different nationalities. Minimum 3, 5* Judges. Minimum 1, 4* Judge. 7 FEI Judges may be used, at least 4 foreign and max. 2 from the same NF. Per diem for Judges: EUR 120*	Judges: 5 from FEI list; at least 3 foreign Judges of different nationalities. Minimum 2, 5* Judges. Minimum 2, 4* Judges. 7 FEI Judges may be used, at least 4 foreign and max. 2 from the same NF. Per diem for Judges: EUR 120*	Judges: 5 from FEI list; at least 3 foreign Judges of different nationalities. One 3* Judge is mandatory in Western Europe and recommended outside Western Europe. A maximum of two 3* Judges are allowed and shall be invited for the big tour. If a small tour is scheduled 2, 2* or 3* Judges may be appointed. Minimum 1, 4* Judge. Outside Western Europe, two (2) of the three (3) foreign Judges may be of the same nationality. 7 FEI Judges may be used, at least 4 foreign and max. 2 from the same NF. Per diem for Judges: EUR 120*

	CDI2*	CDI1*	CDIY/CDIJ/CDIU25	CDIP/CDICH	CDIAM
Participation	No restriction on the number of NFs. All Athletes and Horses must be registered with the FEI. Horses per Athlete left to the discretion of OC.	No restriction on the number of NFs. All Athletes and Horses must be registered with the FEI. Horses per Athlete left to the discretion of OC.	No restriction on the number of NFs. All Athletes and Horses/ponies must be registered with the FEI. Horses per Athlete left to the discretion of OC.	No restriction on the number of NFs. All Athletes and Horses/ponies must be registered with the FEI. Horses per Athlete left to the discretion of OC.	No restriction on the number of NFs. All Athletes and Horses must be registered with the FEI. Horses per Athlete left to the discretion of OC.
Age	Athletes from 16 years.	Athletes from 16 years.	See FEI GRs	See FEI GRs	Athletes from 26 years
Horses	Horses: from 7 years, Medium and Big Tour from 8 years	Horses: from 7 years	Horses: from 6 years. 7 years for PSG level tests. Medium and Big Tour from 8 years	Horses: from 6 years Ponies: from 6 years.	Horses from 7 years, Medium Tour from 8 years
Athletes	Athletes living abroad may compete in Events of their host country, with permission from the NF of their host country	Athletes living abroad may compete in Events of their host country, with permission from the NF of their host country	Athletes living abroad may participate under the jurisdiction of their host country if under 18	Athletes living abroad may participate under the jurisdiction of their host country if under 18	Athletes living abroad may compete in Events of their host country, with permission from the NF of their host country. Athletes must have NO ranking at the FEI Dressage World Ranking List at the date of Definite Entry

DRESSAGE RULES - ANNEX 7 - CATEGORIES OF INTERNATIONAL DRESSAGE EVENTS

	CDI2*	CDI1*	CDIY/CDIJ/CDIU25	CDIP/CDICH	CDIAM
Competitions	Up to FEI Grand Prix excluding FEI Grand Prix Special and FEI Grand Prix Freestyle	Up to FEI Intermediate I including Intermediate I Freestyle	FEI Junior tests FEI Young Riders tests U25: Intermediate A, Intermediate B, Intermediate II, Grand Prix 16-25, Grand Prix Freestyle	FEI Pony Riders tests FEI tests for Children	Up to FEI Grand Prix excluding FEI Grand Prix Special and FEI Grand Prix Freestyle
Horse Passports	FEI passport not required if competing in their home country - these Horses must be registered with their NF, be identifiable by diagram and have a valid vaccination certificate.	FEI passport not required if competing in their home country - these Horses must be registered with their NF, be identifiable by diagram and have a valid vaccination certificate.	FEI passport not required if competing in their home country - these Horses must be registered with their NF, be identifiable by diagram and have a valid vaccination certificate.	FEI passport not required if competing in their home country - these Horses/ponies must be registered with their NF, be identifiable by diagram and have a valid vaccination certificate.	FEI passport not required if competing in their home country - these Horses must be registered with their NF, be identifiable by diagram and have a valid vaccination certificate.
Entry fee	No restrictions	No restrictions	No restrictions	No restrictions	Max CHF 800 (incl VAT)
Bedding-Straw	Optional OC or Athlete expense	Optional OC or Athlete expense	Optional OC or Athlete expense	Optional OC or Athlete expense	Optional OC or Athlete expense
Manure disposal	Max. EUR 40 per Horse	Max. EUR 40 per Horse	Max. EUR 40 per Horse	Max. EUR 40 per Horse	Max. EUR 40 per Horse
	For Events at the same venue over consecutive weekends ("Tours") max. EUR 40.- per Horse may be charged for the first Event of the Tour and max. EUR 20.- per Horse may be charged for each subsequent Event.				
Meals Athletes/grooms	Optional OC or Athlete expense	Optional OC or Athlete expense	Optional OC or Athlete expense	Optional OC or Athlete expense	Optional OC or Athlete expense
Accommodation	Optional OC or Athlete expense	Optional OC or Athlete expense	Optional OC or Athlete expense	Optional OC or Athlete expense	Optional OC or Athlete expense
Footing	No restrictions	No restrictions	No restrictions	No restrictions	No restrictions

DRESSAGE RULES - ANNEX 7 - CATEGORIES OF INTERNATIONAL DRESSAGE EVENTS

	CDI2*	CDI1*	CDIY/CDIJ/CDIU25	CDIP/CDICH	CDIAM
Prize Money	No restrictions	No restrictions	No restrictions	No restrictions	No restrictions
Ground Jury	<p>Judges: Minimum 3. From FEI list of Judges. In a Jury of 5, at least 2 must be foreign and of different Nationalities. In a jury of 3, at least 1 foreign. 1 National Grand Prix Judge from host NF may be appointed in a GJ of 5.</p> <p>Per diem for Judges: EUR 120*</p>	<p>Judges: Minimum 3. From FEI list of Judges. In a Jury of 5, at least 2 must be foreign and of different Nationalities. In a jury of 3, at least 1 foreign. 1 National Grand Prix Judge from host NF may be appointed in a GJ of 3, and 2 in a GJ of 5.</p> <p>Per diem for Judges: EUR 120*</p>	<p>Judges: Minimum 3 FEI Judges One National Judge from host NF may also be appointed in a ground jury of five. In a jury of three members there must be at least two foreign Judges of different nationalities and in a jury of five members there must be at least two foreign Judges of different nationalities (outside Europe, there must be at least one foreign Judge in a jury of three).</p> <p>Per diem for Judges: EUR 120*</p>	<p>Judges: Minimum 3 FEI Judges. One National Judge from host NF may also be appointed in a ground jury of five. In a jury of three members there must be at least two foreign Judges of different nationalities and in a jury of five members there must be at least two foreign Judges of different nationalities (outside Europe, there must be at least one foreign judge in a jury of three).</p> <p>Per diem for Judges: EUR 120*</p>	<p>Judges: Minimum 3. From FEI list of Judges. In a Jury of 5, at least 2 must be foreign and of different Nationalities. In a jury of 3, at least 1 foreign. 1 National Grand Prix Judge from host NF may be appointed in a GJ of 3, and 2 in a GJ of 5. Per diem for Judges: EUR 120*</p>

Categories* of International Official Dressage Events

* only for CDIOs - Special Regulations for FEI Championships and Games.

	CDIO5*	CDIO4*	CDIO3*	CDIO2*	CDIOU25/CDIOY/ CDIOJ/CDIOP/ CDIOCh
Participation	<p>Minimum 6 NF invited including host NF All Athletes and Horses must be registered with the FEI To participate an Athlete/Horse combination must have achieved a minimum of 64% in a <u>Short Grand Prix</u>/Grand Prix at two different CDI3*/ CDI4*, CDI-W/CDI5* or CDIO3*/CDIO4* after 01 January the previous year (Consolation Competitions do not count). 1 Horse per Athlete</p>	<p>Minimum 6 NF invited including host NF All Athletes and Horses must be registered with the FEI 1 Horse per Athlete</p>	<p>Minimum 6 NF invited including host NF All Athletes and Horses must be registered with the FEI 1 Horse per Athlete</p>	<p>Minimum 2 NF invited including host NF All Athletes and Horses must be registered with the FEI 1 Horse per Athlete</p>	<p>Minimum 3 NF invited including host NF All Athletes and Horses/ponies must be registered with the FEI 1 Horse/pony per Athlete</p>
Age	<p>Athletes from 16 years. Horses: from 8 years</p>	<p>Athletes from 16 years. Horses: from 8 years</p>	<p>Athletes from 16 years. Horses: from 8 years</p>	<p>Athletes from 16 years. Horses: from 8 years</p>	<p>Athletes; See FEI GRs, Horses: from 6 years (J/Ch) from 7 years (Y), from 8 years (U25) Ponies: from 6 years</p>
Athletes	<p>Athletes may only participate under the jurisdiction of the country from which they hold their passport.</p>	<p>Athletes may only participate under the jurisdiction of the country from which they hold their passport.</p>	<p>Athletes may only participate under the jurisdiction of the country from which they hold their passport.</p>	<p>Athletes may only participate under the jurisdiction of the country from which they hold their passport.</p>	<p>Over 18: Athletes may only participate under the jurisdiction of the country from which they hold their passport.</p>

DRESSAGE RULES - ANNEX 7 - CATEGORIES OF INTERNATIONAL DRESSAGE EVENTS

	CDIO5*	CDIO4*	CDIO3*	CDIO2*	CDIOU25/CDIOY/ CDIOJ/CDIOP/ CDIOCh
Competitions	FEI Grand Prix, FEI Grand Prix Special and/or FEI Grand Prix Freestyle	FEI Grand Prix, FEI Grand Prix Special and/or FEI Grand Prix Freestyle	FEI Grand Prix, FEI Grand Prix Special and/or FEI Grand Prix Freestyle	Intermediate A, Intermediate B	CDIOY/CDIOJ/ CDIOP: Team Competition Individual competition Individual Freestyle CDIOU25: Intermediate II Grand Prix 16-25 Grand Prix Freestyle CDIOCh: Preliminary test B Team Competition Individual competition
Horse Passports	FEI passport compulsory	FEI passport compulsory	FEI passport compulsory	FEI passport compulsory	FEI passport compulsory
Entry fee	No restrictions	No restrictions	No restrictions	No restrictions	No restrictions
Bedding-Straw	Free stabling and fodder	Free stabling and fodder	Optional OC or Athlete expense	Optional OC or Athlete expense	Optional OC or Athlete expense
Manure disposal	Max. EUR 40 per Horse	Max. EUR 40 per Horse	Max. EUR 40 per Horse	Max. EUR 40 per Horse	Max. EUR 40 per Horse
	For Events at the same venue over consecutive weekends ("Tours") max. EUR 40.- per Horse may be charged for the first Event of the Tour and max. EUR 20.- per Horse may be charged for each subsequent Event.				
Meals Athletes/grooms	3 meals per day	2 meals per day	Optional OC or Athlete expense	Optional OC or Athlete expense	One meal per day must be provided free of charge for Athletes and Chefs d'Equipe
Accommodation	Free accommodation	Free accommodation	Optional OC or Athlete expense	Optional OC or Athlete expense	Optional OC or Athlete expense
Footing	According to min. AIDEO standard (1)	According to min. AIDEO standard (1)	No restrictions	No restrictions	No restrictions

	CDIO5*	CDIO4*	CDIO3*	CDIO2*	CDIOU25/CDIOY/ CDIOJ/CDIOP/ CDIOCh
Prize money	<p>Minimum CHF 100'000 No maximum amount Nations Cup Formula: Grand Prix Team Competition must be highest doted Competition.</p>	<p>Minimum CHF 50'000. Maximum CHF 99'999 Nations Cup Formula: Grand Prix Team Competition must be highest doted Competition.</p>	<p>No minimum amount Maximum CHF 49'999 Nations Cup Formula: Grand Prix Team Competition must be highest doted Competition.</p>	<p>No minimum amount. Maximum CHF 32'999</p>	<p>No restrictions For CDIO-Ch only prizes in kind are allowed. Nations Cup Formula: Team Competition must be highest doted Competition.</p>
Ground Jury	<p>Judges: 5 from FEI list of 5* and 4* Judges. At least 3 foreign Judges of different nationalities. Minimum three 5* Judges. 7 FEI Judges may be used, at least 4 foreign and max. 2 from the same NF. Per diem for Judges: EUR 120*</p>	<p>Judges: 5 from FEI list of 5* and 4* Judges. At least 3 foreign Judges of different nationalities. Minimum two 5* Judges. 7 FEI Judges may be used, at least 4 foreign and max. 2 from the same NF. Per diem for Judges: EUR 120*</p>	<p>Judges: 5 from FEI list of 5* and 4* Judges. At least 3 foreign Judges of different nationalities. 7 FEI Judges may be used, at least 4 foreign and max. 2 from the same NF. Per diem for Judges: EUR 120*</p>	<p>Judges: 5 from FEI list of 3*, 4* and 5* Judges. At least 3 foreign Judges of different nationalities Minimum 2, 4* or 5* Judges. Per diem for Judges: EUR 120*</p>	<p>Judges: Minimum 3 FEI Judges. One National Judge from host NF may also be appointed in a ground jury of five. In a jury of three members there must be at least two Judges of different foreign nationalities and in a jury of five members there must be at least two foreign Judges of different nationalities. Per diem for Judges: EUR 120*</p>

* Remuneration for miscellaneous costs. The amount is net to the Official, after possible taxes.

Definition AIDEO Minimum Standard Footing

The soil has to be elastic and has to have a good grip to enable the hoof to have a gliding phase (not dull) in the sand. The used materials should not be too big, sands and stone meals should not have a grain size higher than 4mm, fleece approximately 30 mm and fibres <50 mm length. The fleece or fibre portion should not be too high. Wood supplements are harmless; however, the wood shavings should not be bigger than 40 x 10 mm (Caution: wood becomes organic). The used materials are not to be too coarse-grained or sharp-edged. Rubber mats could be useful under certain circumstances depending on the drainage. When maintaining the soil, attention is to be paid that the soil does not compress too much, and that the moisture level is adequate. The soil must not stick to the hoofs.

ANNEX 8 - BADGES OF HONOUR

As from 1 January 2005

1. Badges of Honour (with the privileges as outlined in Art. 132 of the FEI GRs) will be awarded on the following scale to Athletes:
 1. who have been among the fifteen (15) best in the Grand Prix at a CDIO:

In	fourteen (14)	CDIO -	Gold Badge
In	ten (10)	CDIO -	Silver Badge
In	six (6)	CDIO -	Bronze Badge
 3. Participation in the Grand Prix Special (FEI Championship Formula) at a CDIO is equal to two (2) CDIOs.
 4. Participation in the Grand Prix Special or Grand Prix Freestyle (Nations Cup Formula) at a CDIO is equal to two (2) CDIOs.
 5. Participation in the Grand Prix Special at FEI Continental Championships, FEI World Championships and the Olympic Games is equal to three (3) CDIOs.
 6. Participation in the Grand Prix Freestyle (FEI Championship Formula) at a CDIO is equal to three (3) CDIOs.
 7. Participation in the Grand Prix Freestyle at FEI Continental Championships, FEI World Championships, the FEI World Cup™ Dressage Final and the Olympic Games, is equal to four (4) CDIOs.
 8. Applications for badges must be accompanied by supporting evidence.

ANNEX 9 – CODEX FOR FEI DRESSAGE JUDGES

The FEI requires that all those officiating in international equestrian sport adhere to the FEI Officials' Code of Conduct (see General Regulations) and to the Codex for FEI Dressage Judges hereafter:

1. The FEI Dressage Judge is an expert on Dressage and Horses, who must have knowledge of the principles of Dressage, of the FEI-Rules and Regulations and, based on their technical competence, is qualified to judge FEI International Dressage competitions.

The Judge is always representing the FEI.

2. A Judge must avoid any actual or perceived conflict of interest. A judge must have a neutral, independent and fair position towards Athletes, owners, trainers, OCs and other Officials and integrate well into a team. Financial and/or personal interest must never influence or be perceived to influence their way of judging.

It is the responsibility of the Judge to be in good health and fit to officiate throughout the duration of the Event.

Activities which will lead to or may lead to a "conflict of interest" when officiating at a CDI, include but are not limited to:

- Training a participating Horse/Athlete for more than three (3) days in the twelve (12) month period prior to an Event or any training of a Horse/Athlete during a period of nine (9) months before Olympic Games, World Equestrian Games, Continental Championship on Grand Prix level, or World Cup Final, and three (3) months before any other FEI Event.
- Nationalistic judging.

A Judge has the responsibility to notify the FEI in writing of any of the above or other possible conflicts of interest or situations that may be perceived as such.

3. A Judge has to be well prepared for the tests they are judging and has to cooperate well with the OC and their colleagues.

4. A Judge has to be dressed appropriately and must always be aware that they are representing the FEI. The use of electronic communication, other than the Judges Signalling system, including mobile phones, is forbidden inside the Judge's huts while judging. Alcohol should not be consumed by Judges until finishing the day's judging. Scores from previous tests must not be used by the Judge while judging.

4.1 Only officiating people (to include Officials fulfilling promotion requirements) are allowed in the Judges' huts. Any exceptions must have the prior approval of the PGJ and must be included in the Foreign Judge report to the FEI. No media nor recording equipment are allowed in the Judges' hut.

5. The FEI and the FEI Dressage Committee have the right to undertake disciplinary actions against judges who do not follow the Codex and the FEI Rules and Regulations.

Such disciplinary actions may consist of (See also GRs - FEI Officials' Code of Conduct):

- Warning letter
- Temporary suspension
- Demotion
- Removal from the FEI Dressage Judges' list

ANNEX 10 - PER DIEM

Per Diem for Judges, Technical Delegates and Stewards:

1. Per diem of EUR 120 per day, (remuneration for miscellaneous costs. This amount is net after relevant taxes being borne by the OC). The per diem is due for all officiating days, plus one. At the discretion of the Official, the per diem for this additional day may be forfeited if the Official can conveniently travel on the officiating days.
2. Judges: for more details see Annex 7
3. Veterinary Delegates: see VR

ANNEX 11 - EQUIPMENT/SADDLERY REFERENCE

This annex is to be used as a reference to Article 428 and must only be used in conjunction with the written rules which take precedence over this annex. The images below are examples only, and similar equipment which produce the same effect on the horse are also allowed if they adhere to the written rules.

Saddles

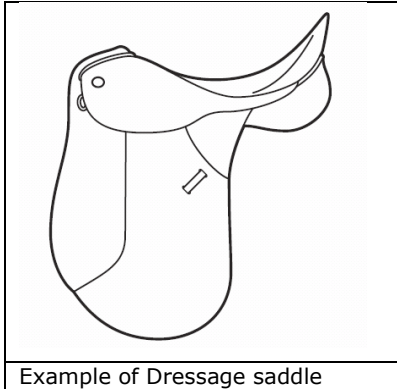

Example of Dressage saddle

Bridles

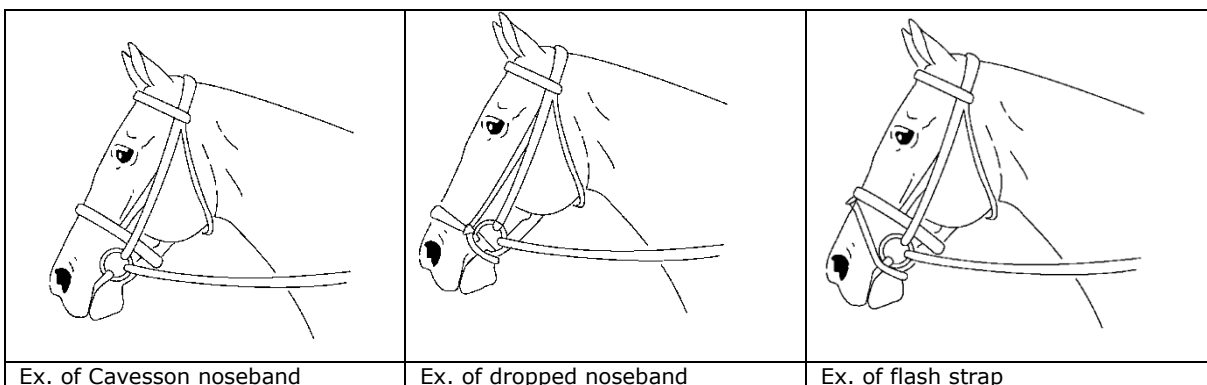
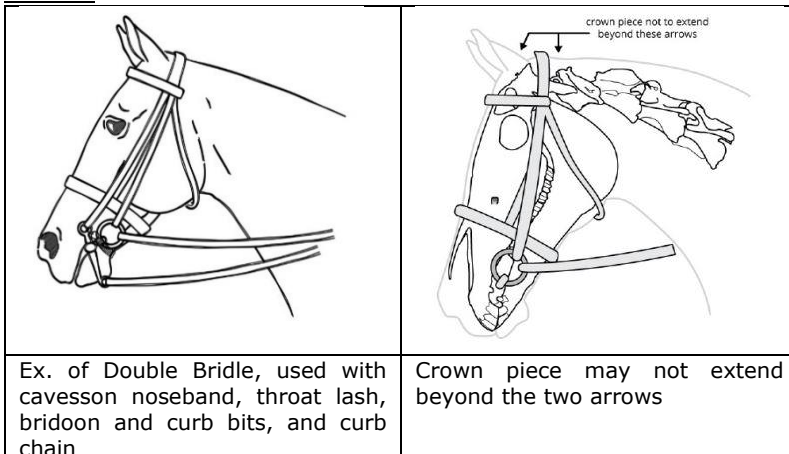

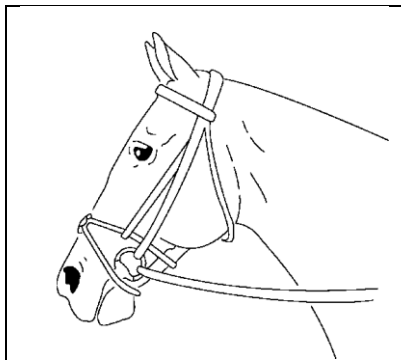
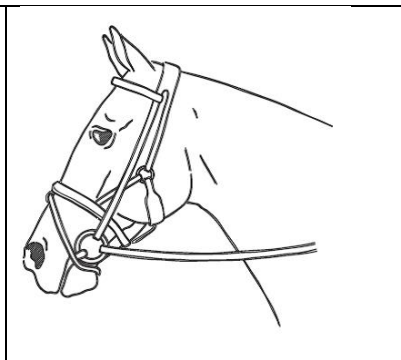
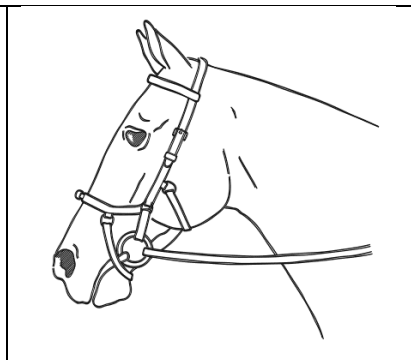
		
Ex. of crossed/mexican/grackle noseband	Ex. of combined noseband – no throat lash necessary	Ex. of Micklem style bridle – no throatlash necessary



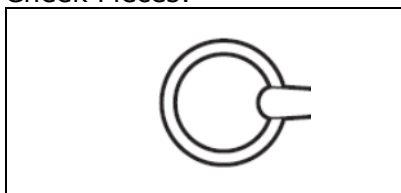
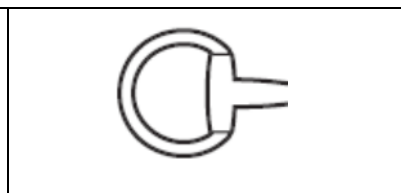
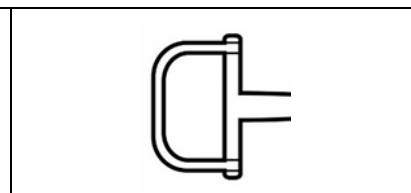
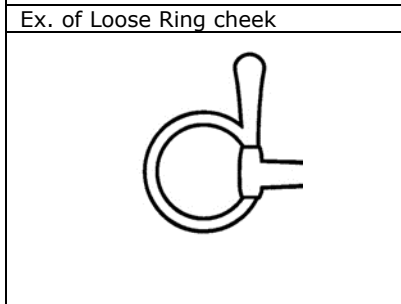
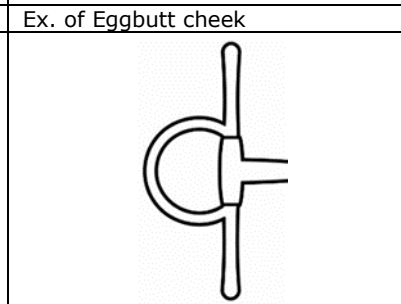
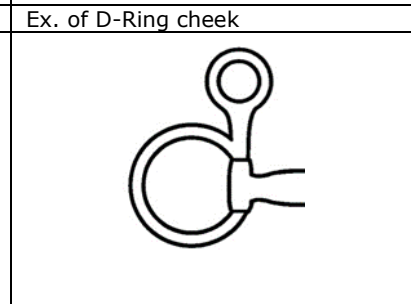
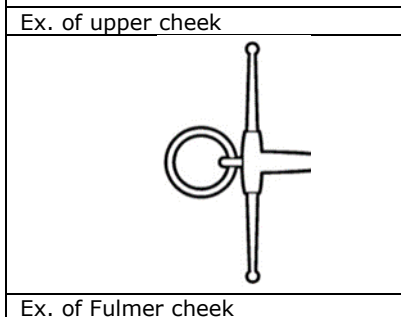

Bits

Cheek Pieces:

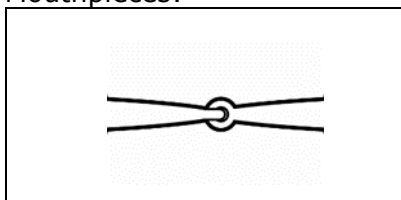
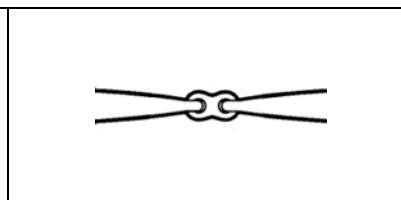
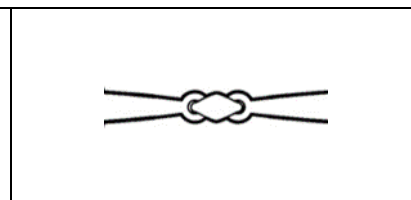
		
Ex. of Loose Ring cheek	Ex. of Eggbutt cheek	Ex. of D-Ring cheek
		
Ex. of upper cheek	Ex. of full cheek	Ex. of hanging cheek
		
Ex. of Fulmer cheek		

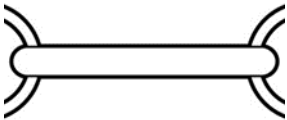
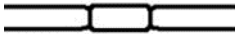
Mouthpieces:



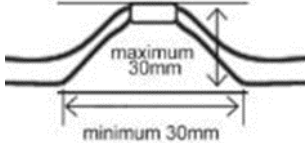

		
Ex. of single jointed mouthpiece	Ex. of double jointed mouthpiece	Ex. of double jointed mouthpiece

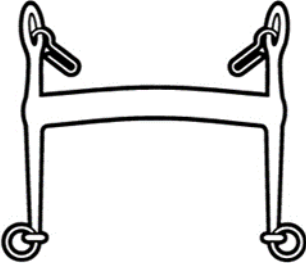
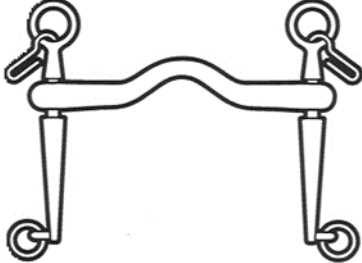
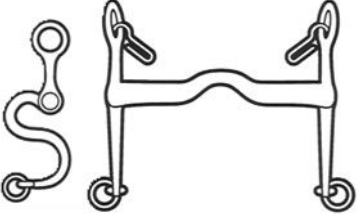
		
Ex. of unjointed mouthpiece	Ex. of barrel joint	Ex. of ball joint
		
Ex. of double ball joint	Ex. of centrepiece with a roller	Port deviation measurements

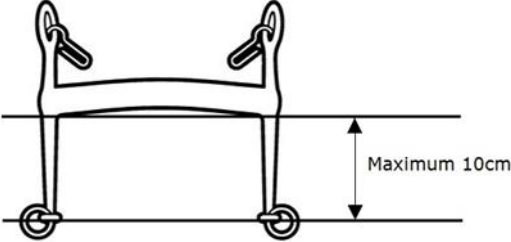
Curb Bits:

		
Ex. of curb with straight cheeks	Ex. of curb with port and sliding mouthpiece (rotating arms also allowed)	Ex. of curb with S cheeks

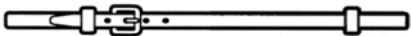
Maximum size of lever arm

	
Ex. of Curb chain	Ex. of Leather cover for curb chain
	
Ex. of lip strap	Ex. of cover for curb chain